

BASKETBALL STAND JUNIOR INSTRUCTION MANUAL

Model: CDB-003



This icon in assembly instructions indicates important notes that users should follow during assembly.



To reduce paper waste and protect the environment, the instruction manual uses less pages and is printed on recycled paper.

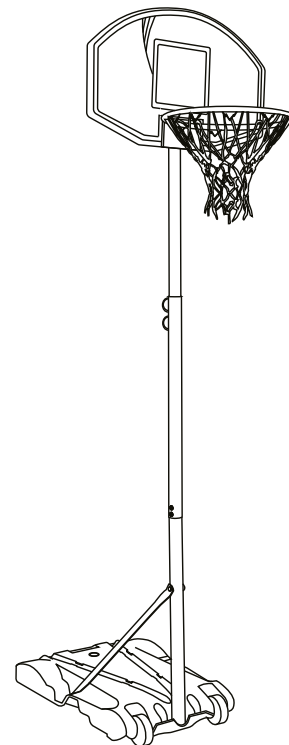

2- PERSON ASSEMBLY

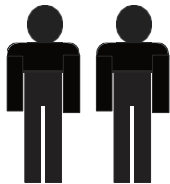

Warranty

We pride ourselves on producing a range of quality products that are both packed with features and completely reliable. We are so confident in our products, we back them up with a one year warranty.

Now you too can relax knowing that you are covered.

Customer Helpline NZ: 0800 222 246

This product is covered by one year warranty when accompanied by proof of purchase.

Marketed by The Warehouse Ltd
26 The Warehouse Way Northcote, Auckland 0627. 0800 422 274

IMPORTANT, RETAIN FOR FUTURE REFERENCE: READ CAREFULLY

Tips Before You Start

Only mount the product on a dry, flat, even surface. The surface beneath the base must be smooth and free of gravel or other sharp objects. Punctures cause leakage and could cause product to tip over.

To ensure safety do not attempt to assemble this product without following the instructions carefully. Check the entire box and inside all packaging material for parts and/or additional instruction material. Read material carefully and identify parts using the hardware identifier and parts list in this manual.

Proper and complete assembly use and supervision are essential for proper operation and to reduce the risk of accident or injury. A high probability of serious injury exists if this product is not installed, maintained and operated properly.







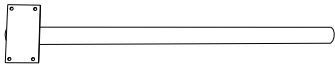

Do not use any other fixings or attachments not provided with the set. These may not offer the same strength or stability and can lead to accident or injury occurring.

Fit the pole sections properly and ensure all parts are securely tightened. Failure to do so could allow the pole sections to separate during play and/or during transport of the product.

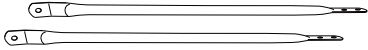
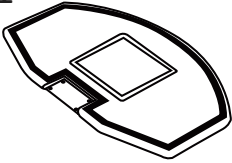
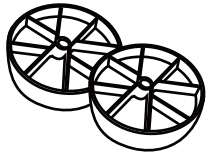
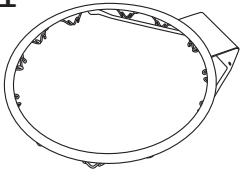
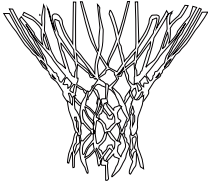
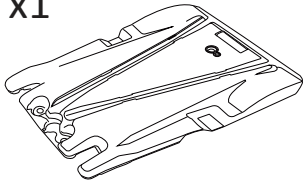
After assembly of the base is complete, fill product completely with water or sand. Never leave product in an upright position without filling base with weight as product may tip over causing injuries.

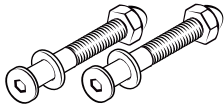
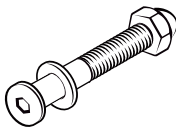
Most injuries are caused by misuse and/or not following instructions. Use caution when using this unit. Two people are needed for assembly. Failure to follow this warning could lead to serious injury or damage to property.

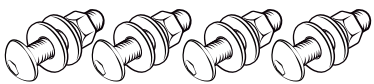
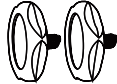
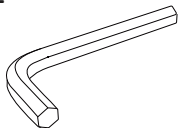
Part List

| | | |
|---|---|---|
| <p>① x1</p>  | <p>② x1</p>  | <p>③ x1</p>  |
| <p>④ x2</p>  | <p>⑤ x1</p>  | <p>⑥ x2</p>  |
| <p>⑦ x1</p>  | <p>⑧ x1</p>  | <p>⑨ x1</p>  |
| <p>⑩ x1</p>  | <p>Ⓐ x2</p>  | <p>Ⓑ x1</p>  |
| <p>Ⓒ x4</p>  | <p>Ⓓ x4</p>  | <p>Ⓔ x2</p>  |
| <p>Ⓕ x1</p>  | <p>Ⓖ x1</p>  | |

Assembly

1

2-PERSON ASSEMBLY





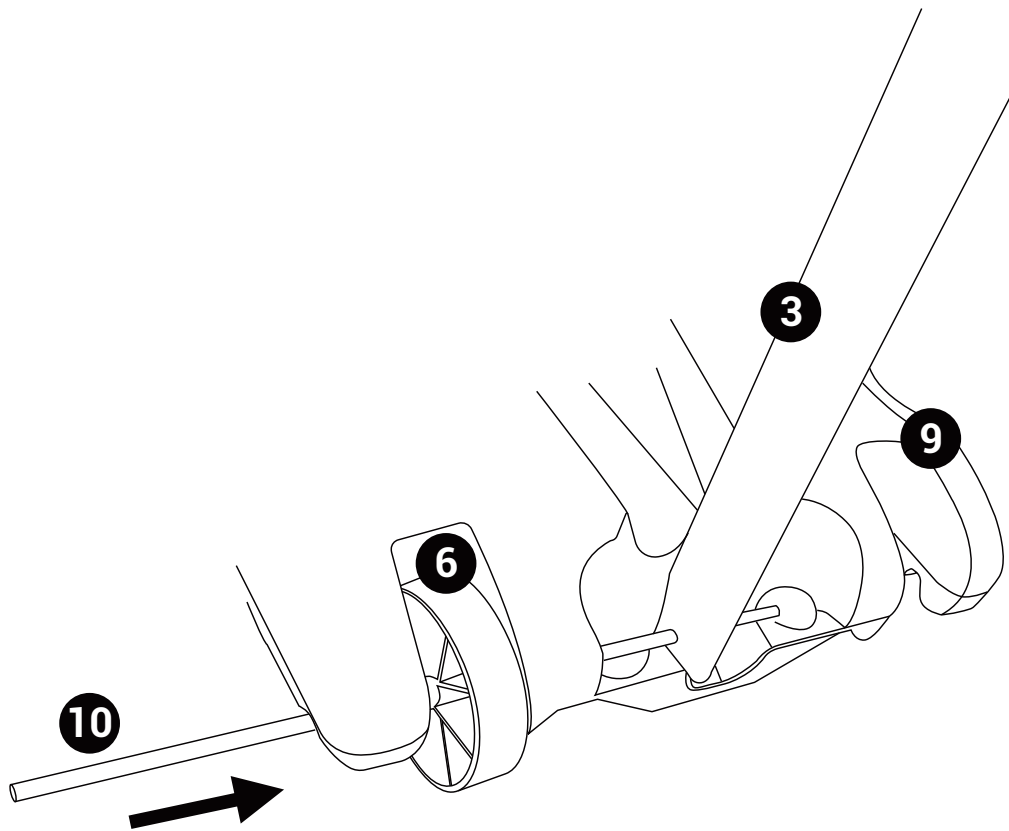



| | | | | | | | |
|---|----|---|----|---|----|----|----|
| 3 | x1 | 6 | x2 | 9 | x1 | 10 | x1 |
|---|----|---|----|---|----|----|----|

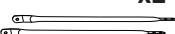

Assembly

2

2-PERSON ASSEMBLY 

| | | | | | |
|---|--|---|--|---|---|
|  4 |  x2 |  B |  x1 |  D |  x4 |
|---|--|---|--|---|---|

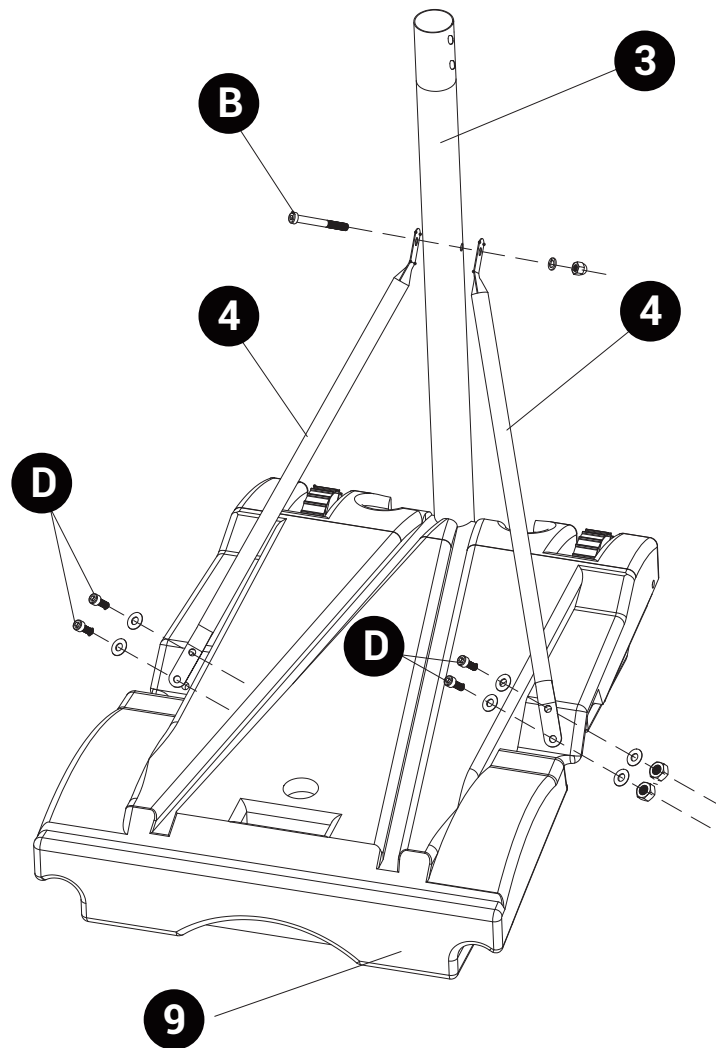

Assembly

3

3- PERSON ASSEMBLY

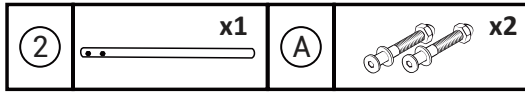



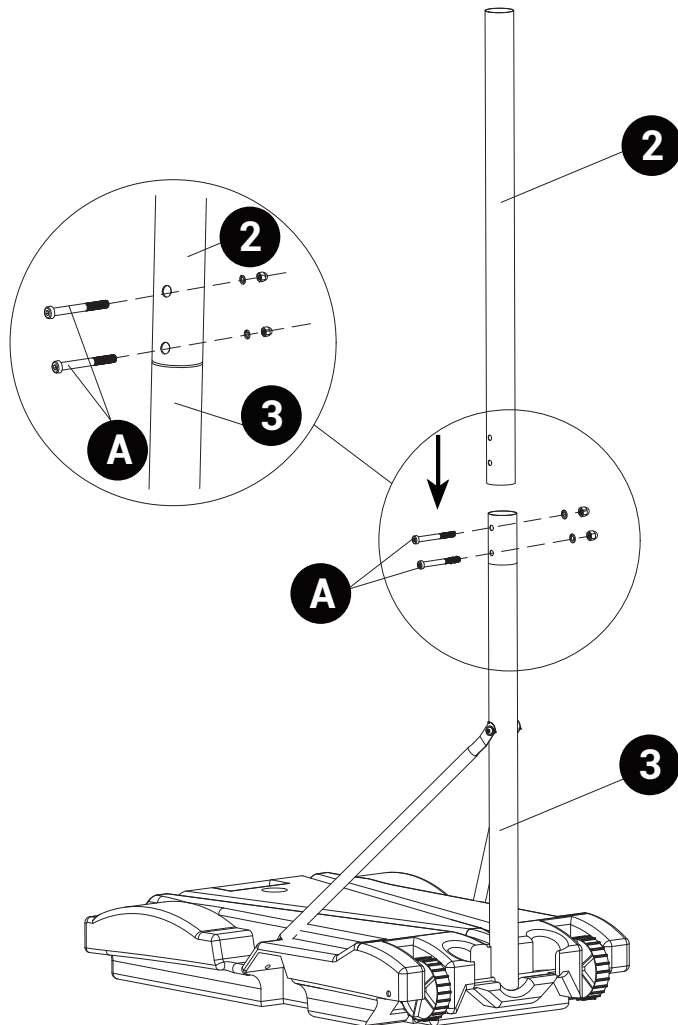

Note: It is recommended 3 people are required to assemble on this point. It is best to assemble while flat on a protective surface.

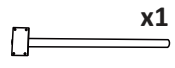

Assembly

4

3- PERSON ASSEMBLY 

| | | | |
|---|--|---|--|
| ① |  x1 | ⑤ |  x1 |
| ⑦ |  x1 | Ⓒ |  x4 |

 **Note:** It is recommended 3 people are required to assemble on this point. It is best to assemble while flat on a protective surface.

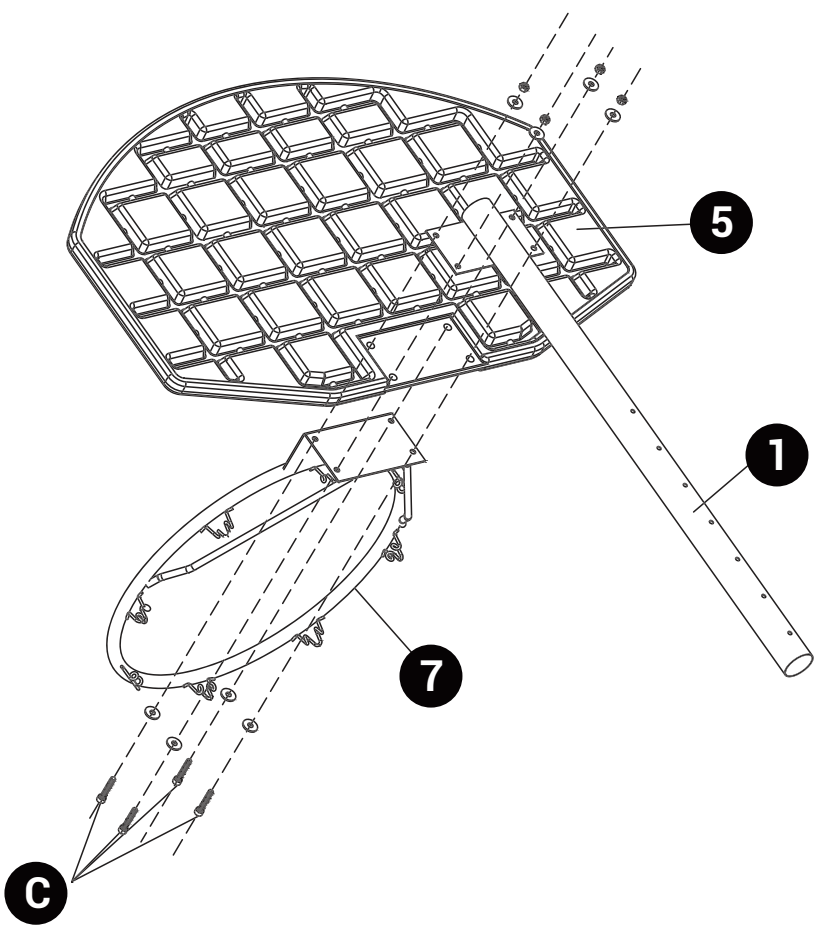

 **Note:** It is best to assemble while flat on a protective surface at this step.

Assembly

5

2-PERSON ASSEMBLY 

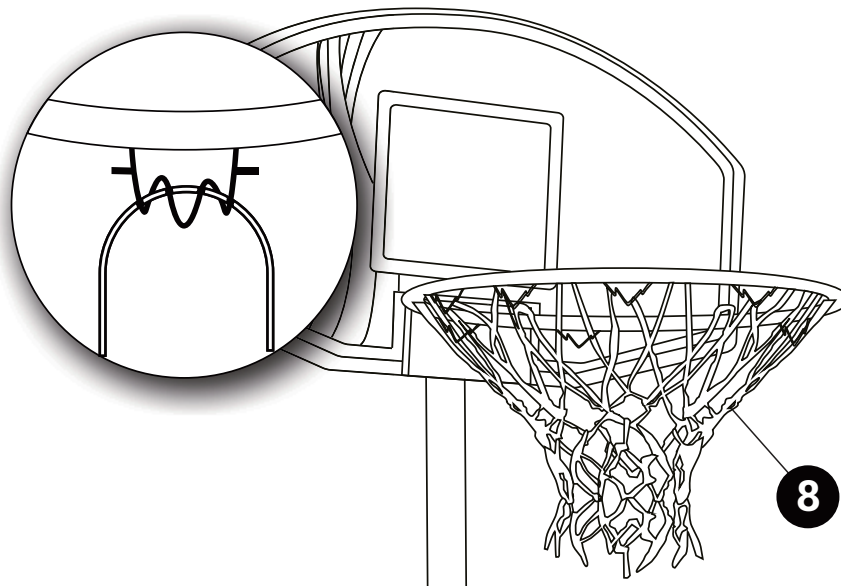
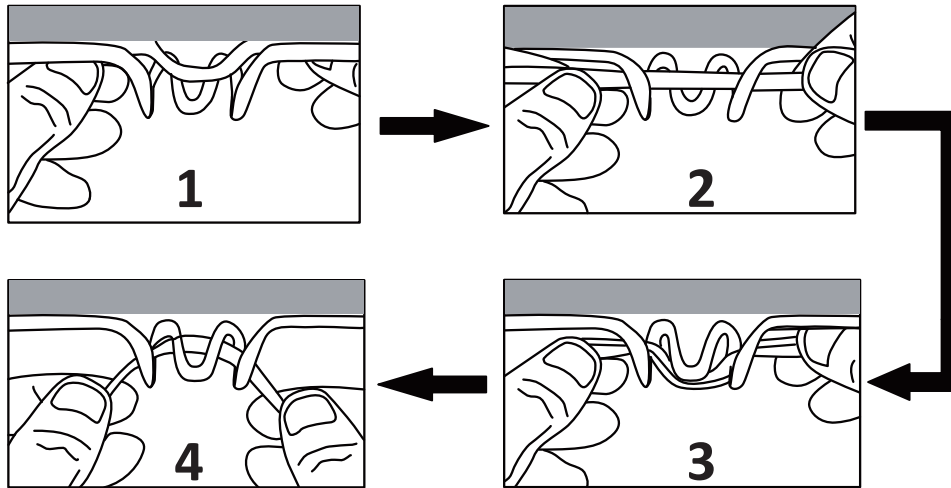

Assembly

6

2- PERSON ASSEMBLY



Note: Hold the upper pole. Loosen tension screw(E) to adjust the height, then tighten it at the proper height.

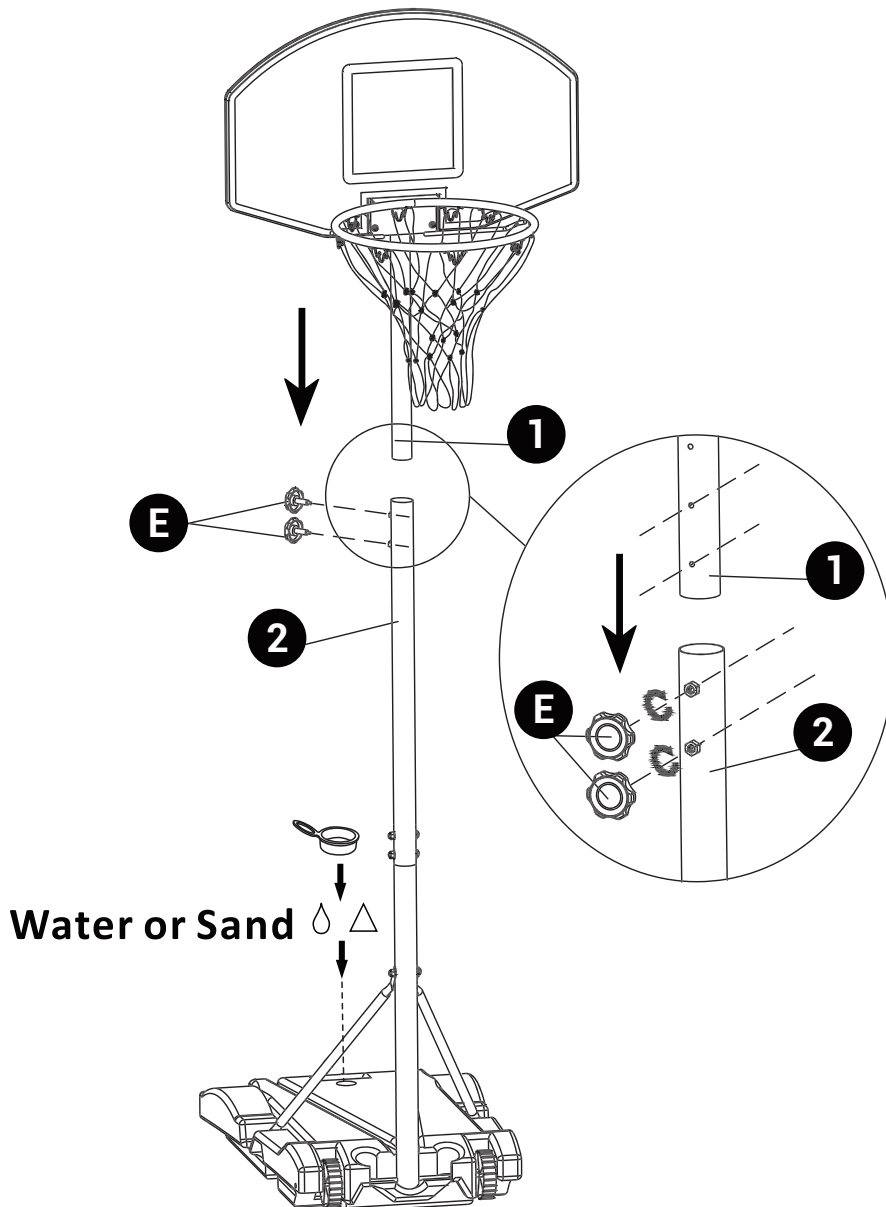

Water or Sand



Note: It is best to assemble while flat on a protective surface at this step.

Warning

Warning! Not suitable for children under three years. Small parts. Long Net. Strangulation Hazard Failure to follow these safety instructions may result in serious injury or property damage and will void the warranty.

A responsible adult must supervise and ensure that all players know and follow these rules for safe operation of the product.

Children should be supervised at all times to ensure they do not climb, mount, sit, lean, upon, adjust, move or misuse the stand in any way. Failure to follow this warning poses a risk of serious injury or property damage.

Do not use this product for commercial purposes. This product is designed for outdoor domestic use only. This basketball stand is not designed for formal match/competitive use. "Dunking" is not allowed since serious injury could occur if teeth/face come into contact with backboard rim or net.

Check the base for leakage before each use. Slow leaks could cause the product to tip over unexpectedly

Check all parts for wear or damage before each use. Do not use if any parts appear broken or damaged.

Climate, corrosion or misuse could result in product failure.

Do not hang on the rim or any part of the product including backboard support braces or net.

Do not slide, climb, shake or play on base and/or pole.

When adjusting height or moving product keep hands and fingers away from moving parts.

Do not allow children to move or adjust product

During play do not wear jewellery(rings, watches, necklaces etc.) Objects may entangle in net.

Do not use this product for anything other than its intended purpose. Misuse can result in serious injury or property damage.

Maintenance

The life of your basketball system depends on many variables. The climate exposure to corrosives such as salt, pesticides or herbicides and excessive use or misuse can all contribute to pole failure, which may cause property damage and/or personal injury.

Keep organic material away from pole base. Grass litter, etc. could cause corrosion and/or deterioration.

Do not use product during windy and/or severe weather conditions; product may tip over.

Place product in the storage position and/or in any areas protected from the wind and free from personal property and/or overhead wires

When moving product use caution to keep mechanism from shifting.

Do not allow water in tank to freeze. Empty the tank completely before storage.

While moving product, do not allow anyone to stand or sit on base or have added ballasting on base.

Do not leave product unsupervised or play on product when it is moving

Use Caution when moving product across uneven surfaces. System may tip over.

When positioning the product, ensure sufficient space for foreseeable future. Do not mount under any live electrical wires, utilities or drains.

Check your basketball system frequently for loose hardware, excessive wear and signs of corrosion. For safety reasons, and to prolong the life of your basketball system, you must take the following preventative measures.

1. Check all nuts and bolts. If any are loose, tighten them.

2. Check all parts for excessive wear and tear. If necessary, replace any parts that have been worn or damaged through usage. Contact our Customer Service Department for replacement parts.

3. Inspect the warning sticker on the pole. If it is ripped, faded or illegible call our Customer Service Department to request a replacement sticker.

4. Check all pole sections for visible rust or chipped or cracked paint. If either is present, do the following:

a) Use an emery cloth to completely remove any rust or chipped paint b) Clean the area with a damp cloth and allow it to dry.

c) Apply two coats of a rust preventative, high gloss enamel paint to the area. Allow the paint to dry between coats.

IF RUST HAS PENETRATED THROUGH THE POLE ANYWHERE, REPLACE IMMEDIATELY!