



| | | |
|--|---|--|
| <p>Portable Goal Set</p> | <p>Barcode: 9401063791637</p> | |
| <p>Estimated Assembly Time 15 Minutes</p> |  <p>1 Person Assembly</p> | <p>SIZE: 76x56x45cm</p>  |
| <p>For Ages 6+ Years</p> | | |

Important Goal SAFETY Instructions:

This equipment must be assembled and disassembled by an adult.
 This goal has been designed to be used for the game of soccer only. Goal posts must be anchored AT ALL TIMES and shall be secured against tilting. Do not climb on the net or goal framework at any time!
 All fastenings must be checked to insure they are fully tightened before and after each use of this product.
 Assembled goal posts should not be left unattended. Remove nets when goals are not in use. Do not use this equipment during the threat of high winds. Goal posts should be checked for safety before and after each use.
 Adult supervision is required at all times.

Care and Maintenance

Please periodically check all fittings are secure and re-tighten if necessary.

Fully disassemble goals for seasonal storage.

WARNING:
 Not suitable for children under
 3 years because of small parts.
CHOKING HAZARD!



IMPORTANT: Read all instructions carefully before using this product.

Retain this owner's manual for future reference.

The photo of this product may vary.

NOTE: Components may be packaged in one or more additional boxes.

Parts List

| No | Parts List | Qty |
|----|------------|-----|
| 1 | NO. 1 TUBE | 2 |
| 2 | NO. 2 TUBE | 2 |
| 3 | NO. 3 TUBE | 2 |
| 4 | NO. 4 TUBE | 2 |
| 5 | NET | 2 |
| 6 | ANCHOR PEG | 4 |

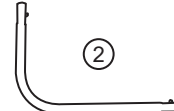
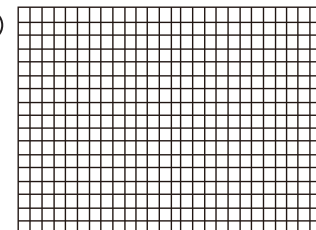
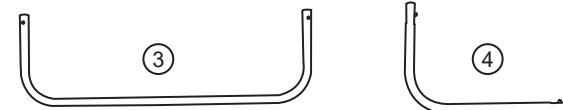
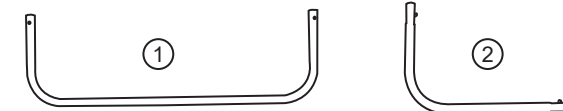

ACTIVE INTENT
SPORT

IMPORTANT - Please check that all parts are present before you start the assembly of your soccer net.

1. Attach the numbered parts in order as shown. Be sure connections are pressed firmly together.

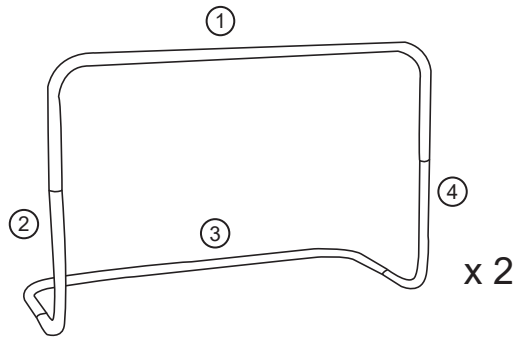

2. Attach the net by putting tubes through the mesh of net edge. Secure the frame to a flat playing surface with the anchor pegs.

