

# Bookcase 5 Tier

1.5hr

APPROXIMATE ASSEMBLY TIME

2 PERSON ASSEMBLY

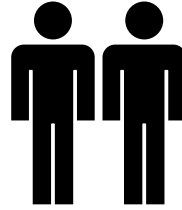

FLOOR AREA  
2M x 3M

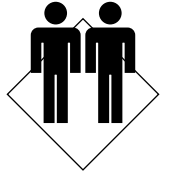

REQUIRED ASSEMBLY SPACE

REQUIRED ASSEMBLY TOOLS

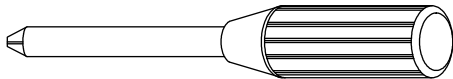

PHILLIPS SCREWDRIVER

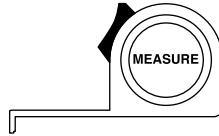

MEASURING TAPE

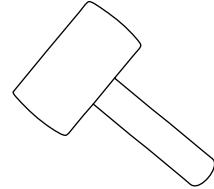

SOFT Mallet/HAMMER

## ASSEMBLED DIMENSIONS

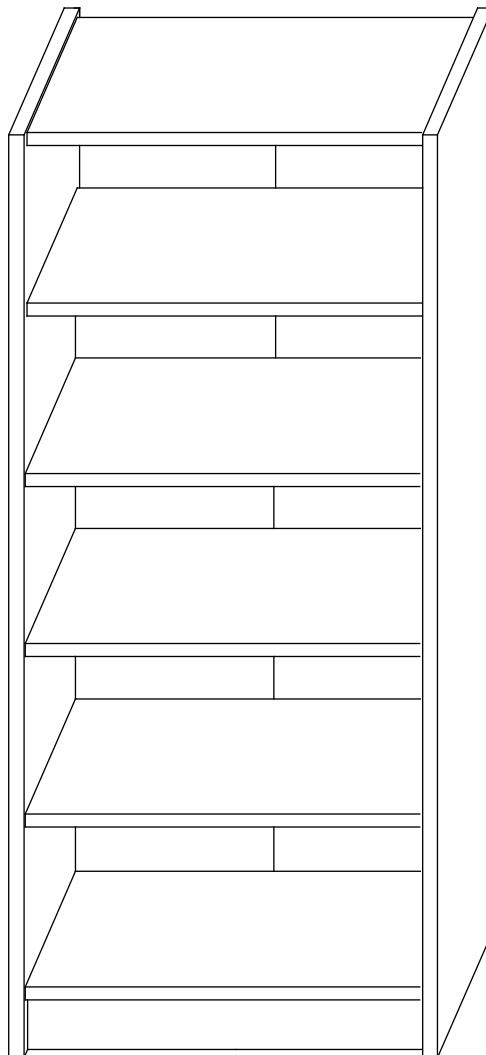

# Bookcase 5 Tier

## Tips before you start:

1. Please check that all parts are present before you start the assembly of your furniture.
2. For ease and speed of assembly, we recommend that before you commence each step of the assembly, that you identify all the parts required for that step.
3. For larger items, please ensure that you have sufficient space and people (as indicated on page 1) to assemble your product safely.
4. We recommend that, where possible, all items are assembled near to the area in which they will be placed in use, to avoid moving the product unnecessarily once assembled.
5. For the protection of your furniture, we recommend that the product is placed on a protected surface during assembly to prevent any damage.
6. During assembly please take care not to over-tighten any fittings, as this may damage the product.
7. Always place the product on a flat, steady and stable surface.
8. Do not stand on the product. Do not use the product as a stepladder.
9. This product is intended for indoor, household use only as it is a non-industrial product.

## Care and Maintenance of your Furniture

- Please periodically check all fittings and re-tighten as necessary.
- To clean your item, please use a damp cloth and wipe clean.
- Never allow any kind of liquid to remain on your furniture. Absorption can cause wood to warp or finishes to de-laminate.
- Please do not place hot items (eg. Hot drinks) directly on to the surface.
- Please do not drag and pull your furniture.

# Bookcase 5 Tier

## HARDWARE LIST

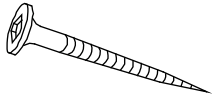

16 x A  
Screw

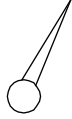

28 x B  
Nail

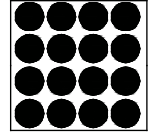

16 x C  
Sticker



12 x D  
Wooden Dowel



1 x E  
Allen Key

## PARTS LIST

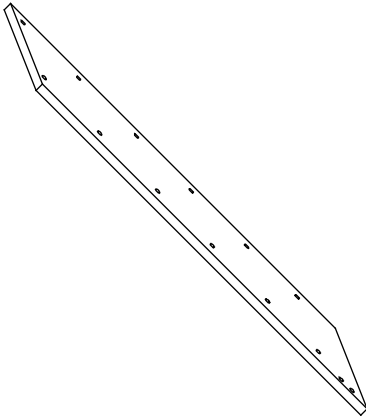
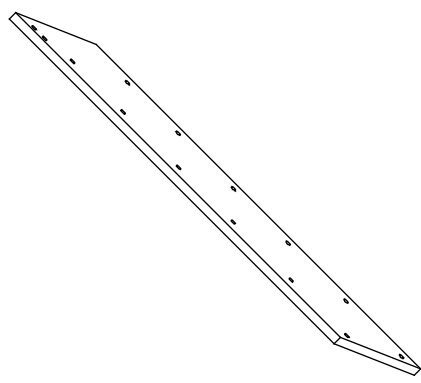
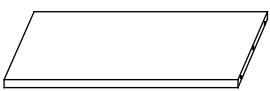
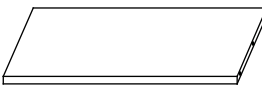
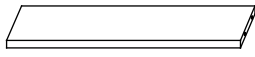
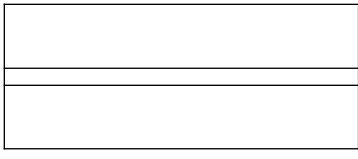
					
1	1 PC	2	1 PC	3	4 PCS
					
4	2 PCS	5	1 PC	6	1 PC

# Bookcase 5 Tier

## STEP 1

Fix panels 3 to panel 1 using screws (A), as shown.

Fit wooden dowels (D) to panels 4 and 5, as shown.

Fit panels 4 and 5 to panel 1, as shown.

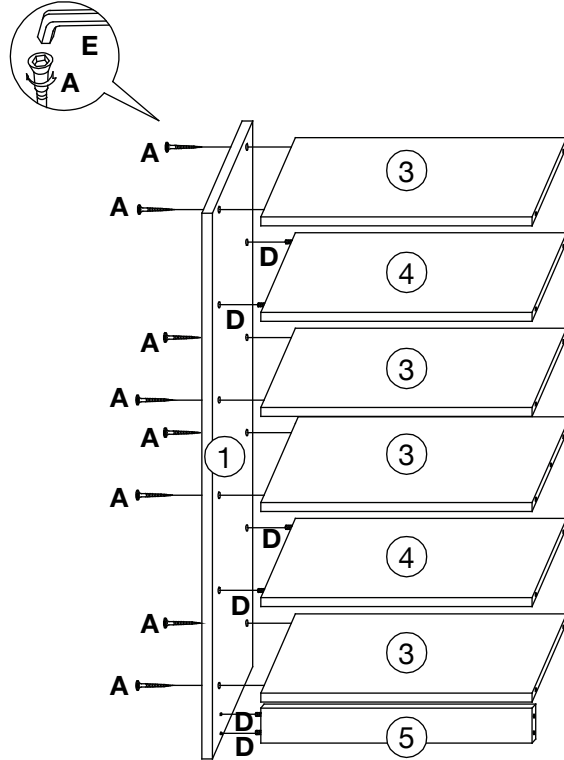

## STEP 2

Fit wooden dowels (D) to panels 4 and 5, as shown.

Fit panel 2 to assembled panels 3, 4 and 5, as shown.

Secure panel 2 by fixing to panels 3 using screws (A), as shown.

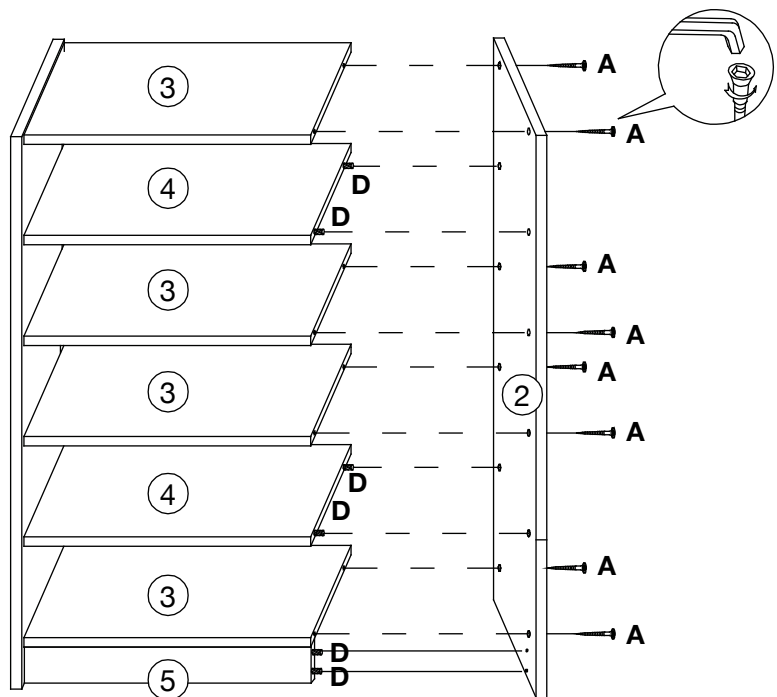

# Bookcase 5 Tier

## STEP 3

Secure back panel 6 using nails (B), as shown.

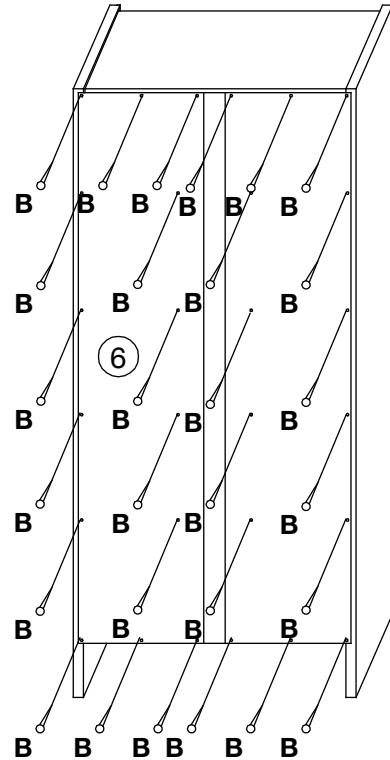

## STEP 4

Cover visible screws with stickers (C).

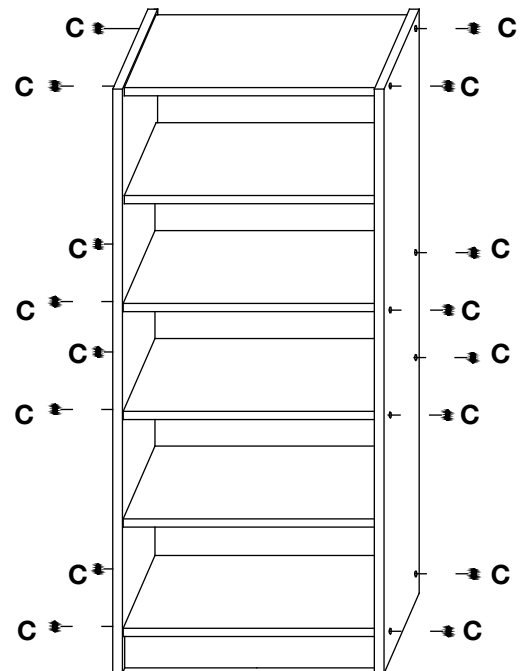

Your Bookcase 5 Tier is ready for use.

**Maximum recommended weight: 10kg per shelf**