

living & co.

20L MICROWAVE OVEN 700W



INSTRUCTION MANUAL EM720C2GXB

AFTER SALES SUPPORT

☎ (NZ) 0800 422 274

CONTENT

PRECAUTIONS TO AVOID POSSIBLE EXPOSURE
TO EXCESSIVE MICROWAVE ENERGY 4

IMPORTANT SAFETY INSTRUCTIONS WARNINGS.....5

GROUNDING INSTALLATION 8

CLEANING 9

UTENSILS 10

SETTING UP YOUR OVEN12

INSTALLATION14

CONTROL PANEL 15

OPERATION 16

TROUBLE SHOOTING 21

WARRANTY22

Read these instructions carefully before using your microwave oven, and keep them for future reference.

If you follow the instructions, your oven will provide you with many years of good service.

SAVE THESE INSTRUCTIONS CAREFULLY

PRECAUTIONS TO AVOID POSSIBLE EXPOSURE TO EXCESSIVE MICROWAVE ENERGY

- (a) Do not attempt to operate this oven with the door open since this can result in harmful exposure to microwave energy. It is important not to break or tamper with the safety interlocks.
- (b) Do not place any object between the oven front face and the door or allow soil or cleaner residue to accumulate on sealing surfaces.
- (c) **WARNING:** If the door or door seals are damaged, the oven must not be operated until it has been repaired by a qualified service person.

CAUTION

If the apparatus is not maintained in a good state of cleanliness, its surface could be degraded and affect the lifespan of the apparatus and lead to a dangerous situation.

SPECIFICATIONS

Model	EM720C2GXB
Rated Voltage/Frequency	230-240 V~50Hz
Microwave Input	1100-1150 W
Microwave Output	650-700 W
Oven Capacity	20L
Turntable Diameter	255mm
External Dimensions	440*318*259mm
Net Weight	Approx. 10.4kg

IMPORTANT SAFETY INSTRUCTIONS WARNING

To reduce the risk of fire, electric shock, injury to persons or exposure to excessive microwave oven energy when using your appliance, follow basic precautions, including the following:

1. Read and follow the specific: " PRECAUTIONS TO AVOID POSSIBLE EXPOSURE TO EXCESSIVE MICROWAVE ENERGY".
2. This appliance can be used by children aged from 8 years and above and persons with reduced physical, sensory or mental capabilities or lack of experience and knowledge if they have been given supervision or instruction concerning use of the appliance in a safe way and understand the hazards involved. Children shall not play with the appliance. Cleaning and user maintenance shall not be made by children without supervision.
3. Keep the appliance and its cord out of reach of children less than 8 years.
4. If the supply cord is damaged, it must be replaced by the manufacturer, its service agent or similarly qualified persons in order to avoid a hazard.
5. WARNING: Ensure that the appliance is switched off before replacing the lamp to avoid the possibility of electric shock.
6. WARNING: It is hazardous for anyone other than a qualified service person to carry out any service or repair operation that involves the removal of a cover which gives protection against exposure to microwave energy.

7. **WARNING:** Liquids and other foods must not be heated in sealed containers since they are liable to explode.
8. When heating food in plastic or paper containers, keep an eye on the oven due to the possibility of ignition.
9. Only use utensils that are suitable for use in microwave ovens.
10. If smoke is emitted, switch off or unplug the appliance and keep the door closed in order to stifle any flames.
11. Microwave heating of beverages can result in delayed eruptive boiling, therefore care must be taken when handling the container.
12. The contents of feeding bottles and baby food jars shall be stirred or shaken and the temperature checked before consumption, in order to avoid burns.
13. Eggs in their shell and whole hard-boiled eggs should not be heated in microwave ovens since they may explode, even after microwave heating has ended.
14. The oven should be cleaned regularly and any food deposits removed.
15. Failure to maintain the oven in a clean condition could lead to deterioration of the surface that could adversely affect the life of the appliance and possibly result in a hazardous situation.
16. The appliance must not be installed behind a decorative door in order to avoid overheating. (This is not applicable for appliances with decorative door.)

17. The microwave oven shall not be placed in a cabinet unless specific clearances from all sides is maintained.
18. This appliance is intended to be used in household and similar applications such as:
 - staff kitchen areas in shops, offices and other working environments;
 - by clients in hotels, motels and other residential type environments;
 - farm houses;
 - bed and breakfast type environments.
19. The microwave oven is intended for heating food and beverages. Drying of food or clothing and heating of warming pads, slippers, sponges, damp cloth and similar may lead to risk of injury, ignition or fire.
20. Metallic containers for food and beverages are not allowed during microwave cooking.
21. The appliance shall not be cleaned with a steam cleaner.
22. The appliance is intended to be used freestanding.
23. The rear surface of appliances shall be placed adjacent to a wall.
24. Ensure the waveguide cover is kept clean by gently wiping its surface with a damp cloth to remove food or liquid contaminants. Failure to maintain can result in permanent damage resulting in sparking / burning of the cover during subsequent use. Should this occur, switch off immediately.

READ CAREFULLY AND KEEP FOR FUTURE REFERENCE

TO REDUCE THE RISK OF INJURY TO PERSONS GROUNDING INSTALLATION DANGER

Electric Shock Hazard

Touching some of the internal components can cause serious personal injury or death. Do not disassemble this appliance.

WARNING

Electric Shock Hazard

Improper use of the grounding can result in electric shock.

Do not plug into an outlet until appliance is properly installed and grounded.

This appliance must be grounded. In the event of an electrical short circuit, grounding reduces the risk of electric shock by providing an escape wire for the electric current.

This appliance is equipped with a cord having a grounding wire with a grounding plug. The plug must be plugged into an outlet that is properly installed and grounded.

Consult a qualified electrician or serviceman if the grounding instructions are not completely understood or if doubt exists as to whether the appliance is properly grounded.

If it is necessary to use an extension cord, use only a 3-wire extension cord.

1. A short power-supply cord is provided to reduce the risks resulting from becoming entangled in or tripping over a longer cord.
2. If a long cord set or extension cord is used:
 - 1) The marked electrical rating of the cord set or extension cord should be at least as great as the electrical rating of the appliance.
 - 2) The extension cord must be a grounding-type 3-wire cord.
 - 3) The long cord should be arranged so that it will not drape over the counter top or tabletop where it can be pulled on by children or tripped over unintentionally.

CLEANING

Be sure to unplug the appliance from the power supply.

1. Clean the cavity of the oven after using with a slightly damp cloth.
2. Clean the accessories in the usual way in soapy water.
3. The door frame and seal and adjacent parts must be cleaned carefully with a damp cloth when they are dirty.
4. Do not use harsh abrasive cleaners or sharp metal scrapers to clean the oven door glass since they can scratch the surface, which may result in shattering of the glass.
5. Cleaning Tip---For easier cleaning of the cavity walls that the food cooked can touch: Place half a lemon in a bowl, add 300ml (1/2 pint) water and heat on 100% microwave power for 10 minutes. Wipe the oven clean using a soft, dry cloth.

WARNING: Failure to regularly clean and maintain surfaces inside the oven cavity (in particular the waveguide cover and surface immediately adjacent), will increase the risk of premature product failure. Use a damp cloth to wipe the waveguide cover after heavy use or in case of food / liquid spillage onto its surface. Contaminants that are not cleaned from the waveguide cover will cause increased heating and risk of insulation break down during subsequent use. This can cause visible sparking / burning of the waveguide cover during use. If this occurs, switch off immediately. The microwave will require replacement of the waveguide cover and safety checks by a qualified service person before subsequent use.

UTENSILS

CAUTION

Personal Injury Hazard

It is hazardous for anyone other than a competent person to carry out any service or repair operation that involves the removal of a cover which gives protection against exposure to microwave energy.

See the instructions on "Materials you can use in microwave oven or to be avoided in microwave oven." There may be certain non-metallic utensils that are not safe to use for microwaving. If in doubt, you can test the utensil in question following the procedure below.

Utensil Test:

1. Fill a microwave-safe container with 1 cup of cold water (250ml) along with the utensil in question.
2. Cook on maximum power for 1 minute.
3. Carefully feel the utensil. If the empty utensil is warm, do not use it for microwave cooking.
4. Do not exceed 1 minute cooking time.

Materials you can use in microwave oven

Utensils	Remarks
Browning dish	Follow manufacturer's instructions. The bottom of browning dish must be at least 3/16 inch (5mm) above the turntable. Incorrect usage may cause the turntable to break.
Dinnerware	Microwave-safe only. Follow manufacturer's instructions. Do not use cracked or chipped dishes.
Glass jars	Always remove lid. Use only to heat food until just warm. Most glass jars are not heat resistant and may break.
Glassware	Heat-resistant oven glassware only. Make sure there is no metallic trim. Do not use cracked or chipped dishes.
Oven cooking bags	Follow manufacturer's instructions. Do not close with metal tie. Make slits to allow steam to escape.
Paper plates and cups	Use for short-term cooking/warming only. Do not leave oven unattended while cooking.
Paper towels	Use to cover food for reheating and absorbing fat. Use with supervision for a short-term cooking only.
Parchment paper	Use as a cover to prevent splattering or a wrap for steaming.
Plastic	Microwave-safe only. Follow the manufacturer's instructions. Should be labeled "Microwave Safe". Some plastic containers soften, as the food inside gets hot. "Boiling bags" and tightly closed plastic bags should be slit, pierced or vented as directed by package.
Plastic wrap	Microwave-safe only. Use to cover food during cooking to retain moisture. Do not allow plastic wrap to touch food.
Thermometers	Microwave-safe only (meat and candy thermometers).
Wax paper	Use as a cover to prevent splattering and retain moisture.

Materials to be avoided in microwave oven

Utensils	Remarks
Aluminum tray	May cause arcing. Transfer food into microwave-safe dish.
Food carton with metal handle	May cause arcing. Transfer food into microwave-safe dish.
Metal or metal-trimmed utensils	Metal shields the food from microwave energy. Metal trim may cause arcing.
Metal twist ties	May cause arcing and could cause a fire in the oven.
Paper bags	May cause a fire in the oven.
Plastic foam	Plastic foam may melt or contaminate the liquid inside when exposed to high temperature.
Wood	Wood will dry out when used in the microwave oven and may split or crack.

OVERVIEW OF OVEN PARTS AND ACCESSORIES

(Images and descriptions are for indicative purposes only and may vary from the actual product).

Remove the oven and all materials from the carton and oven cavity.
Your oven comes with the following accessories:

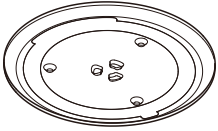

Glass Tray



Turntable Ring Assembly

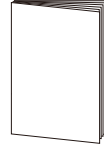

Instruction Manual



Turntable Shaft

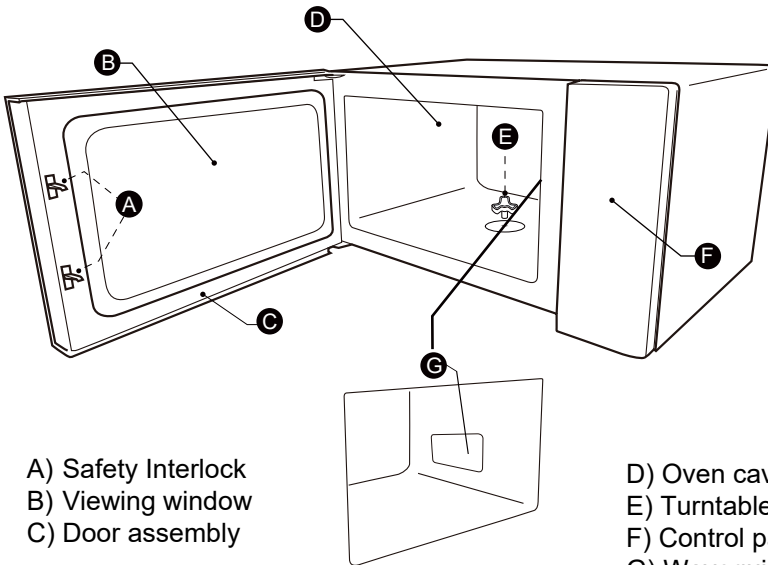

TURNTABLE INSTALLATION

Cleaning the cooking compartment and putting the turntable in place. For new installations, make sure all packaging and shipping tape has been removed from the turntable shaft. Before using the appliance to prepare food for the first time, you will need to put the turntable in place correctly. You must clean the cooking compartment and accessories.

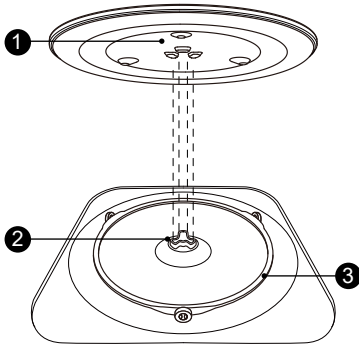

How to put the turntable in place:

1. Place the turntable ring assembly ③ into the recess in the cooking compartment.
2. Place the glass tray ① on the turntable ring assembly ③. Fit the raised, curved lines in the center of the glass tray bottom between the three spokes of the shaft. Make sure that the glass tray ① engages in the turntable shaft ② in the centre of the cooking compartment floor. The rollers on the shaft should fit inside the turntable bottom ridge.

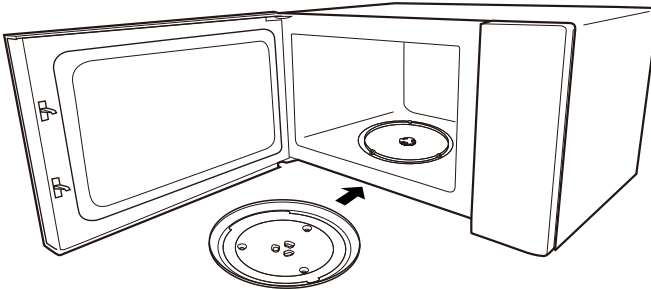

Notes:

1. Never use the appliance without the turntable. Make sure that it is properly engaged. The turntable can turn clockwise or anti-clockwise.
2. Never place the glass tray upside down. The glass tray should never be restricted.
3. Both glass tray and turntable ring assembly must always be used during cooking.
4. All food and containers of food are always placed on the glass tray for cooking.
5. Never restrict the movement of the turntable.
6. If glass tray or turntable ring assembly cracks or breaks, contact your nearest authorised service centre.

Countertop Installation

Remove all packing material and accessories. Examine the oven for any damage such as dents or broken door. Do not install if oven is damaged.

Cabinet: Remove any protective film found on the microwave oven cabinet surface. Do not remove the waveguide cover that is attached to the oven cavity to protect the magnetron.

Installation

1. Select a level surface that provide enough open space for the intake and/or outlet vents.

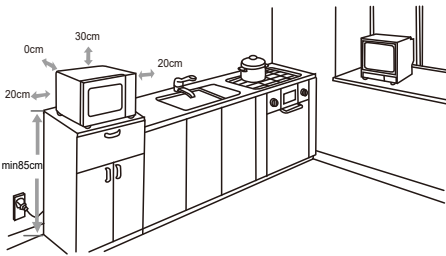

(1) The minimum installation height is 85cm.

(2) The rear surface of appliance shall be placed against a wall.

Leave a minimum clearance of 30cm above the oven, a minimum clearance of 20cm is required between the oven and any adjacent walls.

(3) Do not remove the legs from the bottom of the oven.

(4) Blocking the intake and/or outlet openings can damage the oven.

(5) Place the oven as far away from radios and TV as possible. Operation of microwave oven may cause interference to your radio or TV reception.

2. Plug your oven into a standard household outlet. Be sure the voltage and the frequency is the same as the voltage and the frequency on the rating label.

WARNING: Do not install oven over a range cooktop or other heat-producing appliance. If installed near or over a heat source, the oven could be damaged and the warranty would be void.

The accessible surface may be hot during operation.



CONTROL PANEL

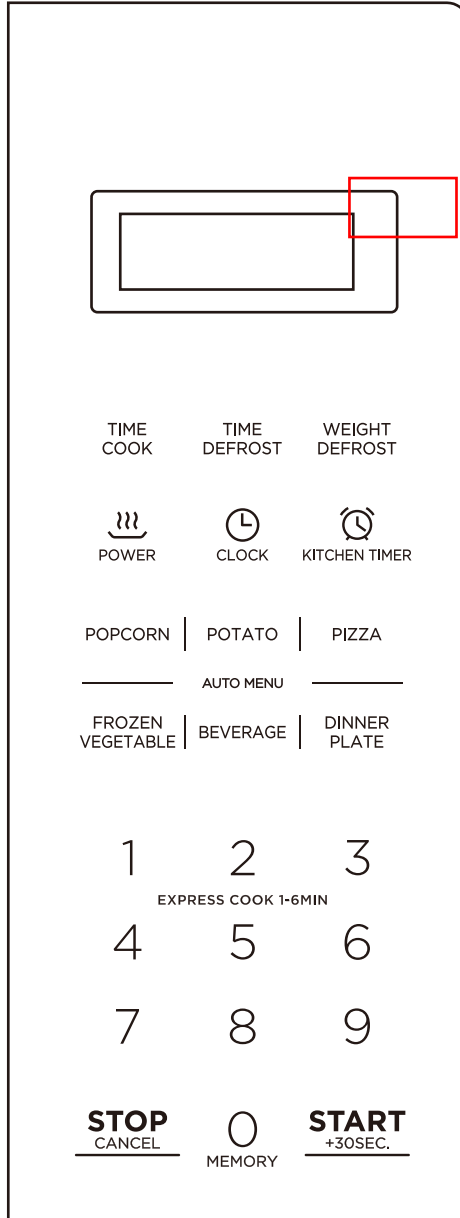

OPERATION

1. Setting the Clock

(1) Press “  ” once and then “00:00” will display.
CLOCK

(2) Press the number keys to enter the time.

Example: To set the clock to 12:10, please press “**1,2,1,0**” in turn.

(3) Press “  ” to confirm. The clock is set.
CLOCK

Notes:

(1) The clock is a 12-hour display. If the clock is not set, it will not work when powered.

(2) To reset the clock, please repeat step 1 to step 3.

2. Setting the Kitchen Timer

(1) Press “  ” once and then “00:00” will display.
KITCHEN TIMER

(2) Press the number keys to enter the desired time. The maximum time value is “99:99”.

(3) Press “ **START** ” to confirm. The timer starts counting down.
+30SEC.

Notes:

(1) The kitchen timer is a timer.

(2) Any other program can't be set during the kitchen timer.

3. Microwave Cooking

11 power levels are available.

Power	100%	90%	80%	70%	60%	50%	40%	30%	20%	10%	0%
Display	PL10	PL9	PL8	PL7	PL6	PL5	PL4	PL3	PL2	PL1	PL0

(1) Press “  ” once and then “ 00:00 ” will display.
TIME COOK

(2) Press the number keys to enter the cooking time. The maximum time value is “ 99:99 ”.

(3) Press “  ” once and then “ PL10 ” will display.
POWER

(4) Press the number keys to adjust the power level. The 11 power levels are available.

(5) Press “ **START** ” to start cooking.
+30SEC.

Notes:

(1) In the process of setting, if the “ **STOP** ” is pressed or if there is no
CANCEL
operation within 1 minute, the setting is invalid.

- (2) If "PL0" is selected, the oven will work with a fan for no power. You can use this level to remove the odor of the oven.
- (3) The power level can be changed during operation. Press "" once and then the current power will display for 3 seconds. Press the number keys to change the power. The oven will work with the selected power.

4. Speedy Cooking

There are two operating methods can be set in speedy cooking.

- (1) In standby mode, press "**START**
+30SEC." to cook food at 100% power level for 30 seconds. Each press on the same key can increase 30 seconds and the maximum time value is "99:99".
- (2) In standby mode, pressing the number keys 1 to 6 lets you quickly select a cooking time from 1 to 6 minutes. You can press "**START**
+30SEC." to increase the cooking time during cooking. The maximum time value is "99:99".

Note: In the microwave cooking and defrosting by time state, each more press on "**START**
+30SEC." can increase the cooking time by 30 seconds.



5. Defrost by Weight

- (1) Press "" once and then the screen will display "dEF1".
- (2) Press the number keys to enter the weight of the food. The range of weight is 100~2000g.
- (3) Press "**START**
+30SEC." to start defrosting.

Note: The buzzer will sound to remind you to turn the food over during defrosting.

If no operation, the oven will continue working.

6. Defrost by Time

- (1) Press "" once and then the screen will display "dEF2".
- (2) Press the number keys to set the desired defrost time. The maximum time value is "99:99".
- (3) Press "" once and then "PL3" will display. Press the number keys to change the power. The oven will work with the selected power.
- (4) Press "**START**
+30SEC." to start defrosting.

18

Notes:

(1) The buzzer will sound to remind you to turn the food over during defrosting.

If no operation, the oven will continue working.

(2) The power level cannot be changed during operation.

7. Auto menu

(1) In standby mode, press the corresponding menu key repeatedly to select the weight of food you want.

For example, press “ POPCORN ” twice and “ 100 ” will display.

(2) Press “ **START** ” to start cooking.
+30SEC.

Auto Menu Chart

Menu	Weight	Display	Power
POPCORN	50g	50	PL10
	100g	100	
POTATO	1(230g)	1	
	2(460g)	2	
	3(690g)	3	
PIZZA	100g	100	
	200g	200	
	400g	400	
FROZEN VEGETABLE	150g	150	
	350g	350	
	500g	500	
BEVERAGE	1(120ml)	1	
	2(240ml)	2	
	3(360ml)	3	
DINNER PLATE	250g	250	
	350g	350	
	500g	500	



8. Multi-Stage Cooking

Notes: (1) Two cooking stages can be set in multi-stage cooking.

(2) If you set the defrost function, it will work automatically in the first stage.

(3) The auto menu cannot be set as one of the multi-stage.

Example: Defrost food for 5 minutes and then cook with 80% microwave power for 7 minutes.



- (1) Press “  ” once and then the screen will display “ dEF2 ”.
- (2) Press “ **5**”, “**0**”, “**0**” to set the desired defrost time of 5 minutes.
- (3) Press “  ” once and then press “**7**”, “**0**”, “**0**” to set the cooking time.
- (4) Press “  ” once and then “PL10” will display.
- (5) Press “**8**” to set the power level of PL8.
- (6) Press “ **START** ” to start cooking.
+30SEC.

9. Memory Function

You can save the settings for a dish in the memory and call it up again.

- (1) Press “  ” repeatedly to select memory 1-3 procedure. “1”, “2” and “3” will display in order.
- (2) If the procedure has been set, press “ **START** ” to start working. Otherwise, please continue to set.
+30SEC.
- (3) After finishing the setting, press “ **START** ” once to save the procedure.
+30SEC.



Example: Set memory 2 (cook food with 80% microwave power for 3 minutes)

- (1) In standby mode, press “  ” twice and “2” will display.
- (2) Press “  ” once and then press the number keys “3”, “0”, “0” in order.
- (3) Press “  ” once and then press the number key “8”.
- (4) Press “ **START** ” to save the setting and “2” will display.
+30SEC.

Notes:

- (1) If the power is not cut off, the procedure will be saved all the time.
- (2) The auto menu cannot be set as a memory function.

10. Inquiring Function

- (1) If the clock has been set, the current time will display for three seconds by pressing “  ” in the cooking state.
CLOCK
- (2) In the microwave cooking state, press “  ” to inquire about the power level.
POWER
- It will display for three seconds.

11. Lock Function for Children

You can use this function to prevent children from accidentally turning the oven on.

To activate the lock:

In standby mode, press and hold “ **STOP** ” for three seconds. A long beep
CANCEL
sounds and the screen will display “[_ _]”.

To deactivate the lock:

In a locked state, press and hold “ **STOP** ” for three seconds. A long beep
CANCEL
sounds.

Trouble shooting

Normal	
Microwave oven interfering TV reception	Radio and TV reception may be interfered when microwave oven operating. It is similar to the interference of small electrical appliances, like mixer, vacuum cleaner, and electric fan. It is normal.
Dim oven light	In low power microwave cooking, oven light may become dim. It is normal.
Steam accumulating on door, hot air out of vents	In cooking, steam may come out of food. Most will get out from vents. But some may accumulate on cool place like oven door. It is normal.
Oven started accidentally with no food in.	It is forbidden to run the unit without any food inside. It is very dangerous.

Trouble	Possible Cause	Remedy
Oven cannot be started.	(1) Power cord is not plugged in tightly.	Unplug. Then plug again after 10 seconds.
	(2) Fuse blowing or circuit breaker works.	Replace fuse or reset circuit breaker (repaired by professional personnel of our company)
	(3) Trouble with outlet.	Test outlet with other electrical appliances.
Oven does not heat.	(4) Door is not closed well.	Close door well.

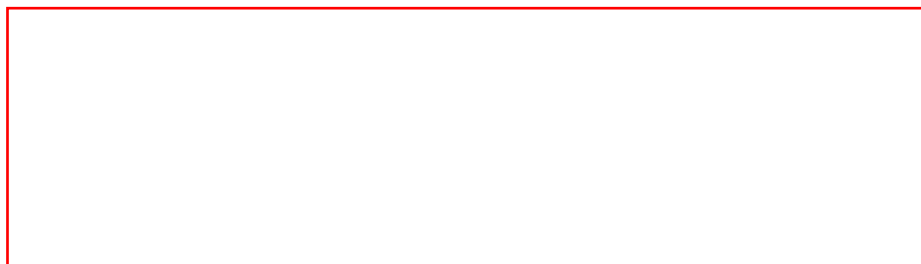

living & co.

Your Living&Co product has been inspected and tested and is guaranteed subject to the following for a period of 12 months from the date of purchase against defects in workmanship and materials. During this period, such defects will be rectified by repair or replacement of the product purchased. Your product contains no user serviceable components and this warranty becomes invalid if in our opinion the product has been misused, abused, incorrectly installed, tampered with, connected to an electrical supply not corresponding with the name plate specification, or subjected to power surges. The warranty does not include any labour or other associated expense that may be involved in removal or installation of the product. Normal wear and tear is expressly excluded.

If your Living&Co product fails to operate satisfactorily, please return it to the retailer from whom it was purchased. To obtain a repair or replacement product under this warranty, you will need to produce satisfactory evidence of date of purchase. The completed warranty and purchase receipt must be presented with the product. The warranty should be filled out at the time of purchase. It is in your interest to make sure this is done.

If the product is to be replaced (cannot be repaired) then that replacement will be of the faulty product or accessory excluding packaging, instruction card etc. Where a replacement product is supplied, this shall be guaranteed for the balance of the original warranty period. Any model that is no longer available will be replaced by a model of a value and with such features as we consider appropriate in the circumstances. Living&Co is not responsible for freight forwarding charges, losses or damage in transit.

If service is required after the warranty period has expired, the product should be returned to a qualified electrical technician. Service outside of the warranty period will be at your cost.

Consumers Guarantee Act (1993).

In accordance with the above act consumers are advised that: The manufacturer does not undertake that repair facilities and parts are necessarily available for this product. If any of the provisions of the foregoing are contrary to any relevant legislation, then that provision shall be deemed to be excluded from the warranty and the rest of the provisions will continue to apply.

IMPORTANT: PLEASE RETAIN THIS WARRANTY CARD

NAME: _____.

ADDRESS: _____.

PURCHASED FROM: _____.

SUBURB: _____.

DATE OF PURCHASE: _____.

NAME OF PRODUCT: _____.

MODEL No: _____.

Made In China. Marketed By: The Warehouse, 26 The Warehouse Way, Northcote, Auckland 0627, 0800 422 274

12 MONTH WARRANTY

living & co.

Warranty

We pride ourselves on producing a range of quality home appliances that are both packed with features and completely reliable. We are so confident in our products, we back them up with a 1 year warranty.

Now you too can relax knowing that you are covered.

Customer Helpline NZ: 0800 422 274

This Product is covered by 1 year warranty when accompanied by proof of purchase.