

LIVING & CO[®]

11L AIR FRYER
2000W



INSTRUCTION MANUAL

MODEL:AF-60A

AFTER SALES SUPPORT

☎ NZ 0800 422 274

CONTENTS

	Page
IMPORTANT SAFEGUARDS	3-4
PARTS DESCRIPTION	5
BEFORE FIRST USE	6
HOW TO USE THE ACCESSORIES	6-7
OPERATION	7-9
CLEANING	9
COOKING GUIDE	10
STORAGE	10
TROUBLE SHOOTING	11

IMPORTANT SAFEGUARDS

When using electrical appliances, basic safety precautions should always be followed including the following:

- Read all instructions before using this appliance.
- Do not touch hot surfaces while it is working.
- Never touch the inside of the appliance while it is operating.
- Do not move the appliance when in use.
- Do not cover the air inlet or the air outlet when the appliance is working.
- Do not use the appliance for any other purpose than described in this manual.
- Do not place anything on top of the appliance when in use and when stored.
- Always turn the appliance OFF and disconnect from mains power when not in use, before attempting to move the appliance, before cleaning or storing.
- Never immerse the appliance, the supply cord and plug in water or any other liquid, nor rinse them under the tap.
- To prevent electric shock and short-circuit, avoid any liquid from entering the appliance.
- If the supply cord or any part is damaged, it must be replaced by a qualified electrician in order to avoid a hazard or the product must be disposed.
- Unplug from outlet when not in use and before cleaning. Allow the appliance to cool down before putting on or taking off parts.
- This appliance is not intended for use by persons (including children) with reduced physical, sensory or mental capabilities, or lack of experience and knowledge, unless they have been given supervision or instruction concerning use of the appliance by a person responsible for their safety.
- Do not leave the appliance unattended when in use. Children should be supervised to ensure that they do not play with the appliance.
- Do not let the cord touch hot surfaces, become knotted or hang from the edge of bench tops.
- Do not place this appliance on or near a hot gas or electric burner, or where it could touch a heated oven.
- Keep the appliance clear of walls, curtains and other heat sensitive materials (leave a minimum distance of 20cm in each direction). Do not place the appliance under shelving or flammable materials when in use.
- Before connecting the appliance to the power supply, check that the voltage indicated on the appliance corresponds with the voltage in your home. If this is not the case, DO NOT use the appliance.
- This appliance is not intended to be operated by means of an external timer or a separate remote-control system.

IMPORTANT SAFEGUARDS (continued)

- The use of accessories not recommended by the appliance manufacturer may cause serious injury or damage to the appliance.
- This appliance is for household use only. Do not use outdoors.
- Do not use this appliance for other than its intended use.
- This appliance is intended to be used in household and similar applications such as:
 - staff kitchen areas in shops, offices and other working environments;
 - farm houses;
 - by clients in hotels, motels and other residential type environments;
 - bed and breakfast type environments.
- Use the appliance only on a dry, level, stable, and heat-resistant surface only, away from any edges.
- Do not use the appliance under overhead cabinets or presses. The steam may cause damage to the cabinets or presses.
- Do not place the appliance close to flammable materials, heating units or within a wet environments (wash rooms / bathrooms etc).
- This appliance must be earthed.
- Never use the appliance with oil.
- Always unplug the power cord from wall outlet socket when the appliance is not in use.
- Always allow the appliance to cool down completely before cleaning.
- Do not put any other cooking pans in the appliance.
- If a lot of smoke is escaping from the air vent during operation, unplug the unit from the mains supply and discontinue use.
- Do not move the unit whilst in operation. Allow the appliance to cool down completely before moving.
- Any repairs to the product must be carried out by a qualified electrical person only.
- Do not disassemble the unit on your own or replace any parts.
- Keep the unit out of reach of children during use or when stored.

**SAVE THESE INSTRUCTIONS FOR FUTURE
REFERENCE**

FOR HOUSEHOLD USE ONLY

PARTS DESCRIPTION

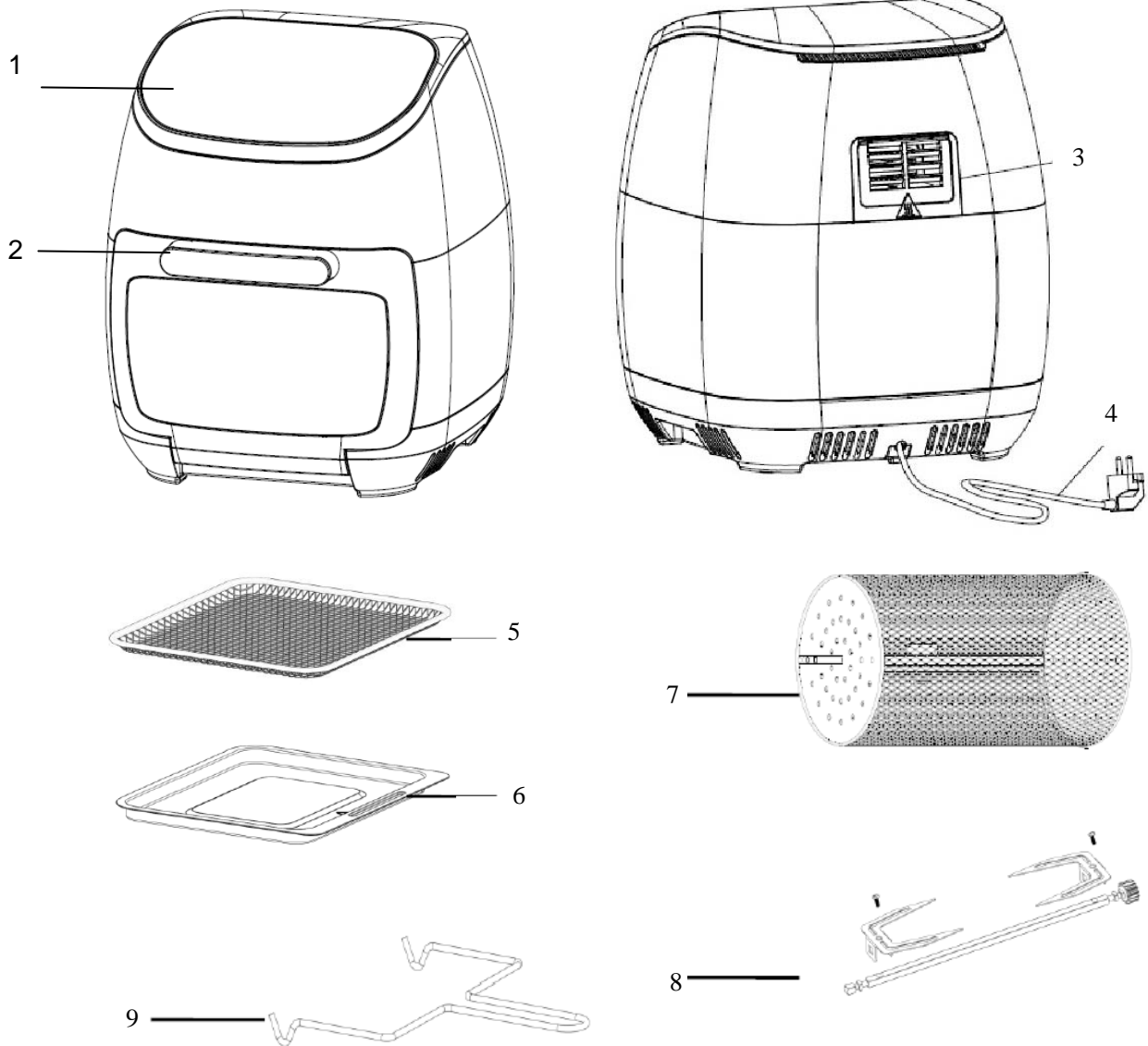

1. Control panel

2. Door handle

3. Hot air outlet

4. Power cord and plug

5. Air flow racks (3pcs)

6. Drip tray

7. Rotating mesh basket (Rotisserie basket)

8. Rotisserie Fork Set

9. Rotisserie basket handle (removal tool)

Technical Specifications

Model	AF-60A
Power Consumption	2000W
Rated Voltage	220-240VAC 50/60Hz
Oven Capacity (gross)	11L
Rotating cage Capacity	3.5L
Adjustable temperature:	65°C—200°C
Timer	(0-60 minutes)

BEFORE THE FIRST USE

1. Remove all packaging materials and stickers or labels.
2. Clean the main unit with a damp cloth or sponge. Wipe dry with a soft dry cloth. Do not immerse the main unit in water or any other liquid.
3. Wipe inside and outside of the appliance with a soft damp cloth and dry thoroughly.
4. Place the appliance on a stable, horizontal and even surface.

WARNING: Do not place the appliance on non-heat-resistant surface.

WARNING! This is an oil-free fryer that works on hot air. Do not fill with oil, frying fat or any other liquid. Fire hazard or personal injury could result!

HOW TO USE THE ACCESSORIES

Air Flow Racks

- The air flow racks can be used not only for dehydration but also to cook crispy snacks or reheat foods like pizza.
- Slide along the rack shelf to install or take out the air flow racks.

NOTE: the maximum weight on the air flow rack must not exceed 1kg.

Rotisserie Basket

- Great for fries, roasting nuts and other snacks.
- Use the hasp (latch) to open and lock the rotisserie basket. To install the rotisserie basket, insert one end of the shaft into the gear wheel at the left-hand side then insert the opposite end into the groove at the right-hand side.

Rotisserie Fork Set

- The rotisserie fork set is used for roasting large meat or whole chicken.
- To install the fork set, place the 1st fork on the shaft then insert the shaft into the gear wheel at the left-hand side. Ensure that the pointy end of the fork faces away from the gear wheel. Force shaft lengthwise through meat/chicken in center. Install the 2nd fork on the shaft. Ensure that the meat is centered towards the middle of the shaft then slide both forks into the meat. Lock the screws to secure the forks. Insert the opposite end of the shaft into the groove at the right-hand side.

Note: Make sure roast or chicken is not too large and can rotate freely within the oven.

Maximum Chicken or Roast , 1.2kg.

HOW TO USE THE ACCESSORIES (continued)

Rotisserie basket handle (removal tool)

- Used to remove the rotisserie basket or fork set from the appliance.
- Place the fetch tool under the shaft at both side of the rotisserie basket or fork set, then gently extract the rotisserie basket or fork set out.

Drip Tray

- Cook with the drip tray for easy clean ups.
- Put the drip tray into the bottom of the appliance when in use. It is easy to take out for cleaning.









Door

- The door is detachable for easy cleaning.
- Open the door at a 30° angle from the appliance and gently put on or take off the door.
- The appliance will not work with the door open.

OPERATION

Hot Air Frying

1. Connect the mains plug into an earthed wall socket.
2. Open the door
3. Put the food to be fried into the air fryer oven
4. To use any of the preset cooking functions, press the  menu button and select the desired preset cooking function icon; the function light will turn on and the preset temperature & cooking time will be displayed on the screen. See preset cooking function detail below:

Icon:	Preset function:	Preset temp:	Preset cook time:	Comments:
	Fries	180°C	20 minutes	If fries are not golden brown or cooked to desired level, cook for a further 5 minutes
	Steak	180°C	20 minutes	Adjust coking time depending on thickness of meat, rare will require less than the preset time
	Drumsticks	180°C	20 minutes	Ensure the chicken is well cooked and juices run clear, extend cooking time if required
	Fish	180°C	18 minutes	Vary as required.
	Shrimp	160°C	12 minutes	Vary as required.
	Roast Chicken	200°C	40 minutes	Ensure the chicken is well cooked and juices run clear, extend cooking time if required
	BBQ Skewer	200°C	20 minutes	Some meats may require the cooking time to be extended.
	Dried Fruit	45°C	4 hours	Cooking time will be dependent on moisture level of the fruit.

OPERATION (continued)

5. To manually select the time and temperature according to different types of food (see Cooking guide for suggested cooking times)



a) Adjust the time by pressing   buttons to increase / decrease by 1 minute intervals. Press and hold for 2 seconds to rapidly increase or decrease time.

Tip: You can also adjust the time while the machine is operating.

b) Adjust the temperature by pressing   buttons to increase or decrease temperature by 5°C intervals. Press and hold for 2 seconds to rapidly increase or decrease temperature. Minimum temperature is 65°C up to a maximum of 200°C)

Tip: You can also adjust the temperature while the machine is operating.

After setting the time and temperature, press the  button, the electric heating element and the fan start to work, the power light stops flashing and goes steady, the temperature and time display indicators stay on, and the time starts counting down.

Note: During operation, if the  button is pressed, the fan and the electric heating element turn off and the power light flashes. By pressing the  button again, the fan and the electric heating element turn back on.

Note: During operation if the door is opened, the electric heating element and fan will turn off immediately. If the light was on previously, it will switch off after 3 minutes.

6. To activate the rotisserie function, press the  button. The  button flashes and the rotisserie begins to rotate. To stop, press the button again.

7. To activate the light, press the  button. The button flashes while the light is active. To turn off the light, press the button again

8. When the timer expires, the buzzer will sound 5 times continuously and the time will display "00". Open the door and take food out with the Rotisserie basket handle (removal tool or use a pair of thermally insulated gloves).

Note: During the hot air frying process, the heating indicator symbol () will go on / off. This indicates that the heating element is switching on and off to maintain the set temperature.

Excess oil from the ingredients is collected on the bottom of the drip tray.

9. Check if your food is ready.

If not, place the food back in the fryer and cook for a few minutes more.

Note: During cooking, take care as hot steam may escape from the hot air outlet.

OPERATION (continued)

Settings

The **Cooking Guide** on the following page will help you to select the basic settings depending on the food type. **Note:** Keep in mind that these settings are indicative only. As ingredients differ in origin, size, shape as well as brand, we cannot guarantee the best setting for your ingredients.

- Smaller ingredients usually require a slightly shorter preparation time than larger ingredients.
- Add some oil to fresh potatoes for a crispy result. Place ingredients in the Air Fryer within a few minutes of adding the oil.
- Do not place extremely greasy ingredients such as sausages in the Air Fryer
- Snacks that can be prepared in an oven can also be prepared in the Air Fryer
- The optimal amount for preparing crispy fries is 700 grams.
- Use pre-made dough to prepare filled snacks quickly and easily. Pre-made dough also requires a shorter preparation time than home-made dough.
- Place a baking tin or oven dish on one of the racks if you want to bake a cake or quiche or if you want to fry fragile ingredients or filled ingredients
- You can also use the Air Fryer to reheat ingredients. To reheat ingredients, set the temperature to 150°C for up to 10 minutes.

CLEANING

Clean the appliance after every use.

Do not use metal kitchen utensils or abrasive cleaning materials to clean the drip tray, as this may damage the non-stick coating.

1. Remove the mains plug from the wall socket and let the appliance cool down.

TIP: By opening the door, the air fryer will cool faster.

2. Wipe the outside of the appliance with a moist cloth.
3. Clean all removable parts with hot water, detergent and a non-abrasive sponge.
You can use degreasing liquid to remove any remaining dirt.
4. Clean the inside of the appliance with hot water, some detergent and a non-abrasive sponge.

COOKING GUIDE

	Min-max Amount (g)	Time (min.)	Temperature (°C)
Potato & fries			
Thin frozen fries	600-700	15-20	180
Thick frozen fries	600-700	20-25	200
Potato gratin	800-1000	25-30	200
Meat & Poultry			
Steak	500-800	10-15	180
Pork chops	500-800	10-15	180
Hamburger	400-800	10-15	180
Sausage roll	400-800	13-15	200
Drumsticks	400-800	25-30	180
Chicken breast	400-800	15-20	180
BBQ Skewer	400-600	18-25	200
Chicken	500-1000	30-40	200
Snacks			
Spring rolls	500-800	8-10	200
Frozen chicken nuggets	500-1000	6-10	200
Frozen fish fingers	500-800	6-10	200
Frozen bread crumbed cheese snacks	500-800	8-10	180
Stuffed vegetables	400-800	10	160
Baking			
Cake	800	20-25	160
Quiche	800	20-22	180
Muffins	800	15-18	200
Sweet snacks	800	20	160

STORAGE

- 1 Unplug the appliance and let it cool down.
- 2 Make sure all parts are clean and dry.
- 3 Store in a dry dust free environment protected from exposure to excessive heat and moisture.

TROUBLE SHOOTING

Problem	Possible cause	Solution
The Air Fryer does not work	The appliance is not plugged in.	Put the mains plug in an earthed wall socket.
The food is not cooked properly	The cavity has been over-filled with food	Put smaller batches of ingredients in the air fryer oven. Smaller batches are fried more evenly.
	The preparation time is too short.	Set the time to the desired temperature setting on the control panel (see point 5a under Hot Air Frying section).
	The set temperature is too low.	Set the temperature to the desired temperature setting on the control panel (see point 5b under Hot Air Frying section).
Fried snacks are not crispy when they come out of the air fryer.	You used a type of snacks meant to be prepared in a traditional deep fryer.	Use oven snacks or lightly brush some oil onto the snacks for a crispier result.
	The drip tray still contains grease residues from previous use.	White smoke is caused by grease heating up in the drip tray. Make sure you clean the drip tray properly after each use.
Fresh fries are fried unevenly in the air fryer.	The incorrect potato type was used	Use fresh potatoes and make sure they stay firm during frying.
	The potato pieces were not properly rinsed before you fried them.	Rinse the potato pieces properly to remove starch from the surface. For best results, soak freshly peeled, cut and washed potato fries in water overnight to extract excess starch, this prevents fries sticking to each other & helps to achieve crispy fries.
Fresh fries are not crispy when they come out of the air fryer.	The crispiness of the fries depends on the amount of oil and water in the fries.	Ensure the potato sticks are dried properly before oiling them.
		Cut the potato sticks smaller for a crispier result.
		Add slightly more oil for a crispier result.



LIVING & CO[®]

Warranty

We pride ourselves on producing a range of quality home appliances that are both packed with features and completely reliable. We are so confident in our products, we back them up with 2 years warranty.

Now you too can relax knowing that you are covered.

Customer Helpline NZ: 0800 422 274

This Product is covered by 2 years warranty when accompanied by proof of purchase