



Kensington

Model No.: KWS2046Q-D1W



INSTRUCTION MANUAL

Electric Oven

**Please read the manual carefully
before use. Keep them for further reference.**

Contents

	Page
IMPORTANT SAFEGUARDS	2-3
BEFORE USING YOUR ELECTRIC OVEN	3
PRODUCT OVERVIEW	3
OPERATING INSTRUCTIONS	4-5
CLEANING INSTRUCTIONS / STORAGE / SPECIFICATIONS:	5

IMPORTANT SAFEGUARDS

When using an electrical appliance, basic safety precautions should always be followed, including the following. Read all instructions and keep in a safe place for future reference.

1. Extreme caution must be used when moving an appliance containing hot oil or other hot liquids.
2. Do not touch hot surfaces. Use handles or knobs.
3. Close supervision is necessary when any appliance is used by or near children.
4. To protect against electric shock, do not place any part of the electric oven in water or other liquid.
5. Do not let cord hang over edge of table or counter, or touch hot surfaces.
6. Do not operate the appliance with a damaged cord or plug or after the appliance malfunctions, or has been damaged in any manner, return appliance to the nearest Authorized Service Center for examination or repair.
7. The use of accessory attachments not recommended by the appliance manufacturer may cause hazard or injury.
8. Keep at least four inches of space on all sides/ rear of the oven to allow for adequate air circulation.
9. Unplug from outlet when not in use, or before cleaning. Leave to cool before before cleaning.
10. To disconnect, turn the control to STOP, then unplug the appliance plug. Always hold the plug body, never try to remove the plug by pulling on the cord.
11. Do not cover TRAY or any part of the oven with metal foil. This may cause overheating of the oven.
12. Do not clean with metal scouring pads. Pieces can break off the pad and touch electrical parts, creating a risk of electric shock.
13. Oversized foods or metal utensils must not be inserted in a electric oven as they may create a fire or risk of electric shock.
14. A fire may occur if the oven is covered or touching flammable material, including curtains, draperies, walls, and the like, when in operation. Do not store any item on the oven during operation.
15. Extreme caution should be taken when using containers constructed from anything other than metal or glass.
16. Do not place any of the following materials in the oven: cardboard, plastic, paper, or anything similar.
17. Do not store any materials, other than manufacturer's recommended accessories, in this oven when not in use.
18. Always wear protective, insulated oven mitts when inserting or removing items from the hot oven.
19. This appliance has a tempered, safety glass door. The glass is stronger than ordinary glass and more resistant to breakage. Tempered glass can break, but the pieces will not have sharp edges. Avoid scratching door surface or nicking edges.
20. Do not use outdoors and do not use appliance for other than intended use.
21. This appliance is for HOUSEHOLD USE ONLY.
22. The temperature of the door or the outer surface may be higher when the appliance is working.
23. Temperature of accessible surfaces may be high when the appliance is operating.
24. Do not rest cooking utensils or baking dishes on glass door.
25. This appliance is not intended for use by persons (including children) with reduced physical, sensory or mental capabilities or lack of experience and knowledge, unless they have been given supervision or instruction concerning use of the appliance by a person responsible for their safety.
26. Children should be supervised to ensure that they do not play with the appliance.
27. The maximum weight placed on the food Tray/Wire Rack must not exceed 3.0kg.
NOTE: Try to distribute the food evenly over the length of the rack.
28. If the supply cord is damaged, it must be replaced by the manufacturer, its services agent or similarly qualified persons in order to avoid a hazard.
29. WARNING: Surfaces, other than the functional surfaces may develop high temperatures. Since temperatures are perceived differently by different people, this device should be used with CAUTION.
30. Appliances are not intended to be operated by means of an external timer or separate remote-control system.
31. Do not place on or near a hot gas or electric burner, or in a heated oven.

CAUTION: APPLIANCE SURFACES ARE HOT AFTER USE. ALWAYS wear protective, insulated oven gloves when touching hot oven or hot dishes and food, or when inserting or removing rack, pans or baking dishes.

Before Using Your Electric Oven

Before using your convection electric oven for the first time, be sure to:

1. Unpack the unit fully.
2. Remove all racks and pans. Wash the racks and pans in hot soapy water or in a dishwasher.
3. Thoroughly dry all accessories and re-assemble in the oven. Plug oven into a suitable electric socket outlet and you are ready to use your new Electric Oven.
4. After re-assembling your oven, we recommend that you run it at MAX temperature for approximately 15 minutes in a well ventilated space to eliminate any packing oil that may remain after shipping.

Product Overview

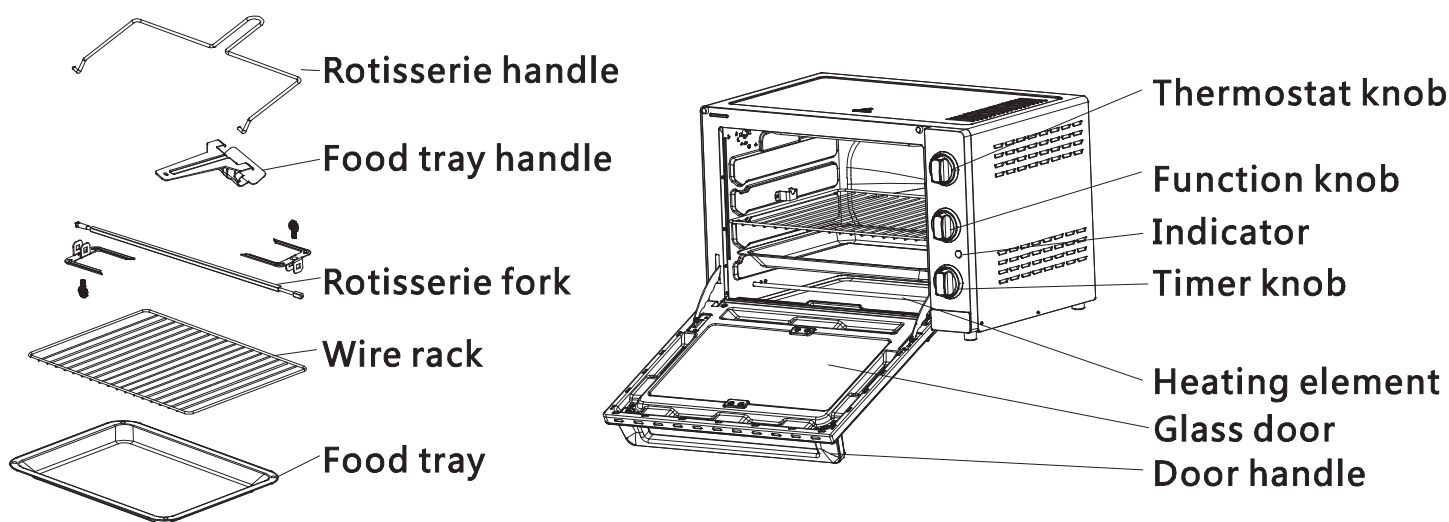

Please familiarize yourself with the following oven functions and accessories prior to first use:



- **Wire rack:** For toasting, baking, and general cooking in casserole dishes and standard pans.
- **Food Tray:** For use in broiling and roasting meat, poultry, fish, and various other foods.
- **Rotisserie Fork:** Use to roast a variety of meats and poultry.
- **Food Tray Handle:** Allow you to pick up Food Tray and Wire rack.
- **Rotisserie Handle:** Allow you to pick up rotisserie spit.
- **Thermostat knob:** choose desired temperature from low 90° C - 230° C (Low is room ambient)
- **Timer knob:** turn control to the left (counter - clockwise) and the oven will STAY ON until manually shut off. To activate timer, turn to right (clockwise) for 15 minute intervals to 90 minutes. A bell will sound at end of programmed time.
- **Function knob:** there are five modes (☐ standby mode, ☐ upper and lower heating elements, ☐ upper heating elements + rotisserie ☐ upper heating elements + convection, ☐ upper and lower heating elements + convection, ☐ upper and lower heating elements + convection + rotisserie)
- **Indicator light (power):** this is illuminated whenever the oven is turned on.

OPERATION INSTRUCTIONS

1. FUNCTION

This function is ideal for cooking bread, pizza, and fowl in general.

Operation



- (1) Place the food to be cooked on the Wire rack / food tray. Insert the rack/tray into the middle support guide of the oven.
- (2) Turn the **Function knob** to  & .
- (3) Set the **Thermostat knob** to the desired temperature.
- (4) Set the **Timer knob** to the desired cooking time.
- (5) To check or remove food, use a handle to help slide food in and out.
- (6) When toasting is complete, a bell will sound the **Timer knob** will back to off position automatically. Open door completely and remove the food immediately or the heat remaining in the oven will continue to toast and dry out your toast.

CAUTION: Cooked food, metal rack, and door can be very hot, handle with care.

2. FUNCTION &

This function is ideal for cooking chicken wings, chicken legs and other meats.

Operation

- (1) Place the food to be cooked on the Wire rack / food tray. Insert the rack/tray into the middle support guide of the oven.
- (2) Turn the **Function knob** to  & .
- (3) Set the **Thermostat knob** to the desired temperature.
- (4) Set the **Timer knob** to the desired cooking time.
- (5) To check or remove food, use a handle to help slide food in and out.
- (6) When toasting is complete, a bell will sound the **Timer knob** will back to off position automatically. Open door completely and remove the food immediately or the heat remaining in the oven will continue to toast and dry out your toast.

CAUTION: Cooked food, metal rack, and door can be very hot, handle with care.



3. FUNCTION &

This function is ideal for cooking whole chickens and fowl in general.

Note: All toasting times are based on meats at refrigerator temperature. Frozen meats may take considerably longer. Therefore, use of a meat thermometer is highly recommended.

Rotisserie fork use: insert pointed end of spit through fork, making sure points of fork face same direction as pointed end of spit, slide towards square of spit and secure with thumbscrew. Place food to be cooked on spit by running spit directly through center of food. Place second fork into other end of roast or poultry. Check that food is centered on spit. Insert pointed end of spit into drive socket, located on right-hand side of oven wall. Make sure the square end of spit rests on spit support, located on left-hand side of oven wall.

Operation

- (1) Place the food to be cooked on the rotisserie fork. Insert the fork into the spit support of the oven.
- (2) Turn the **Function knob** to  & .

OPERATION INSTRUCTIONS (Continued)

- (3) Set the **Thermostat knob** to the desired temperature.
- (4) Set the **Timer knob** to the desired cooking time.
- (5) To check or remove food ,use a handle to help side food in and out.
- (6) When toasting is complete, a bell will sound the **Timer knob** will back to off position automatically. Open door completely and remove the food with handle.

CAUTION: Cooked food, metal fork, and door can be very hot, handle with care. Do not leave the oven unattended.

CLEANING INSTRUCTIONS

CAUTION: To protect against electrical shock, DO NOT IMMERSE THE OVEN IN WATER OR ANY OTHER LIQUIDS.

Your toaster oven should be cleaned regularly for best performance and long life. Regular cleaning will also reduce the risk of fire hazard.

Step 1. Remove plug from electrical outlet. Allow it to cool.

Step 2. Remove the Removable Rack, Tray by pulling out of the oven. Clean them with damp, soapy cloth. Make sure to only use mild, soapy water.

Step 3. To clean inside of oven, wipe the oven walls, bottom of oven, and glass door with a damp, soapy cloth. Repeat with a dry, clean cloth.

Step 4. Wipe outside of oven with a damp cloth.

CAUTION: DO NOT USE ABRASIVE CLEANERS OR METAL SCOURING PADS. Make sure to only use mild, soapy water. Abrasive cleaners, scrubbing brushes and chemical cleaners will damage the coating on this unit. Pieces can break off the and touch electrical parts involving a risk of electrical shock.

Step 5. Allow the appliance to cool and dry completely before storing. If storing the oven for long periods of time make certain that the oven is clean and free of food particles. Store the oven in a dry location such as on a table or countertop or cupboard shelf. Other than the recommended cleaning, no further user maintenance should be necessary.

Any other servicing should be performed by an authorized service representative.

STORAGE

Unplug unit, allow it to cool, and clean before storing. Store the Electric Oven in its box in a clean, dry place. Never store appliance while it is hot or still plugged in. Never wrap cord tightly around the appliance. Do not put any stress on the cord where it enters the unit, as it could cause the cord to fray and break.

SPECIFICATION:

Model	KWS2046Q-D1W
Rated voltage	220V-240V
Rated frequency	50Hz
Rated power	2000W
Oven capacity	46Litres
Household use only , DO NOT IMMERSE IN WATER	