

VEON™

Quick Start Guide

VNG22F5022

VNG22F5522

VNG22F6522

VNG22F7522

4K UHD LED LCD TELEVISION

Support Freeview UHF Live TV

WARNING AND PRECAUTION

Read all of the instructions before operating the set. Keep these instructions well for later use.



WARNING:

TO REDUCE THE RISK OF ELECTRIC SHOCK DO NOT REMOVE COVER(OR BACK). NO USER SERVICEABLE PARTS INSIDE. REFER TO QUALIFIED SERVICE PERSONNEL.







The lightning flash with arrowhead symbol, within an equilateral triangle, is intended to alert the user to the presence of uninsulated " dangerous voltage" within the products enclosure that may be of sufficient magnitude to constitute a risk of electric shock to persons.









The exclamation point within an equilateral triangle is intended to alert the user to the presence of important operating and maintenance(servicing) instructions in the literature accompanying the appliance.

Important Safety Instructions

- Read these instructions – All the safety and operating instructions should be read before this product is operated.
- Keep these instructions – The safety and operating instructions should be retained for future reference.
- Heed all warnings – All warnings on the appliance and in the operating instructions should be adhered to.
- Follow all instructions – All operating and use instructions should be followed.
- Do not use this apparatus near water – The appliance should not be used near water or moisture – for example, in a wet basement or near a swimming pool, and the like.
- Clean only with dry cloth.
- Do not block any ventilation openings. Install in accordance with the manufacturer's instructions.
- Do not install near any heat sources such as direct sunlight, radiators, heat registers, stoves, or other apparatus (including amplifiers) that produce heat.
- Keep out of reach of young children. This television is not suitable for use by young children or infirm persons without supervision. Young children must be supervised to ensure that they do not play with the television.
- This television is not intended for use by persons (including young children) with reduce physical, sensory or mental capabilities, or lack of experience and knowledge, unless they are supervised or have been given instructions concerning the use of the television by a person who is responsible for their safety.
- Protect the power cord from being walked on or pinched particularly at the plugs, convenience receptacles, and at the point where they exit from the apparatus.
- Only use attachments/accessories specified by the manufacturer.
-  Use only with the cart, stand, tripod, bracket, or table specified by the manufacturer, or sold with the apparatus. When a cart or rack is used, use caution when moving the cart/apparatus combination to avoid injury from tip-over.
- Unplug the apparatus during lightning storms or when unused for long periods of time.
- Refer all servicing to qualified personnel. Servicing is required when the apparatus has been damaged in any way, such as power supply cord or plug is damaged, liquid has been spilled or objects have fallen into the apparatus, the apparatus has been exposed to rain or moisture, does not operate normally, or has been dropped.

- CAUTION: These servicing instructions are for use by qualified service personnel only. To reduce the risk of electric shock, do not perform any servicing other than that contained in the operating instructions unless you are qualified to do so.
- Do not install this equipment in a confined or building-in space such as a book case or similar unit, and remain a well ventilation conditions at open site. The ventilation should not be impeded by covering the ventilation openings with items such as newspaper, table-cloths, curtains etc.
- Please refer the information on rear enclosure for electrical and safety information before installing or operating the apparatus.
- To reduce the risk of fire or electric shock, do not expose this apparatus to rain or moisture.
- The apparatus shall not be exposed to dripping or splashing and that no objects filled with liquids, such as vases, shall be placed on the apparatus. Do not use the set near dust place.
- For the terminals marked with symbol of "⚡" may be of sufficient magnitude to constitute a risk of electric shock. The external wiring connected to the terminals requires installation by an instructed person or the use of ready-made leads or cords.
- To prevent injury, use the stand/wall-mount bracket to securely install this apparatus on the table/wall in accordance with the installation instructions.
- Danger of explosion if battery is incorrectly replaced. Replace only with the same or equivalent type.
- The battery (battery or batteries or battery pack) shall not be exposed to excessive heat such as sunshine, fire etc.
- Excessive sound pressure from earphones and headphones can cause hearing loss. Listening to music at high volume levels and for extended durations can damage one's hearing. In order to reduce the risk of damage to hearing, one should lower the volume to a safe, comfortable level, and reduce the amount of time listening at high levels.
- The appliance coupler is used as disconnect device, the disconnect device shall remain readily operable.
- When not in use and during movement, please take care of the power cordset, e.g. tie up the power cordset with cable tie or something like that. It shall be free from sharp edges and the like that can cause abrasion of the power cordset. When put into use again, please make sure the power cordset being not damaged, If any damages found, please look for the service person to replace the power cordset specified by the manufacturer or have the same characteristics as the original one.
- Attention should be drawn to environmental aspects of battery disposal.
-  Protective earthing terminal. The apparatus should be connected to a mains socket outlet with a protective earthing connection.(Only for Class I appliance)
- No naked flame sources, such as lighted candles, should be placed on the apparatus. To prevent the spread of fire, keep candles or other open flames away from the apparatus at all times.
- If the apparatus have the symbol  in its rating label and the power cord has two pins, it means that the equipment is a Class II or double insulated electrical appliance. It has been designed in such a way that it does not require a safety connection to electrical earth.(Only for Class II appliance)
- If the apparatus doesn't have the symbol  in its rating label and its power cord has three pins, it means protective earthing connection is needed. The apparatus should be connected to a mains socket outlet with a protective earthing connection.(Only for Class I appliance)
- The following information are recommended to be included as far as applicable where applicable:

 Refer to alternating current(AC).	 Refer to ClassII equipment.	 Refer to stand-by.
 Refer to direct current(DC).	 Refer to dangerous voltage.	 Refer to power ON.

- Never place a television set in an unstable location. A television set may fall, causing serious personal injury or death. Many injuries, particularly to children, can be avoided by taking simple precautions such as:
 - Using cabinets or stands recommended by the manufacturer of the television set.
 - Only using furniture that can safely support the television set.
 - Ensuring the television set is not overhanging the edge of the supporting furniture.
 - Not placing the television set on tall furniture (for example, cupboards or bookcases) without anchoring both the furniture and the television set to a suitable support.
 - Not placing the television set on cloth or other materials that may be located between the television set and supporting furniture.
 - Educating children about the dangers of climbing on furniture to reach the television set or its controls.

If the existing television set is going to be retained and relocated, the same considerations as above should be applied.

Positioning the TV

- Install Display on solid horizontal surface such as a table or desk. For ventilation, leave a space of at least 10cm free all around the set. To prevent any fault and unsafe situations, please do not place any objects on top of the set. This apparatus can be used in tropical and/or moderate climates.
- Fix the rear of enclosure to wall(only for some countries)

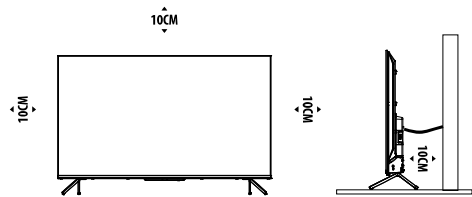

Note: The picture is only for reference.

Mounting on a Wall

- An optional wall mount can be used with your television. Consult with your local dealer to purchase the recommended wall mount bracket. Carefully attach the wall mount bracket at the rear of the TV. Install the wall mount bracket on a solid wall perpendicular to the floor. If you are attaching the TV to other building materials, please contact qualified personnel to install the wall mount. Detailed instructions will be included with the wall mount. Please use a wall mount bracket where the device is adequately secured to the wall with enough space to allow connectivity to external devices.

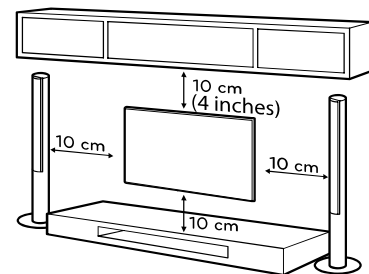

Note: The picture is only for reference.

- Disconnect the power before moving or installing the TV. Otherwise electric shock may occur.
- Remove the stand before installing the TV on a wall mount by performing the stand attachment in reverse.
- If you install the TV on a ceiling or slanted wall, it may fall and result in severe injury. Use an authorized wall mount and contact the local dealer or qualified personnel. Otherwise it is not covered by the warranty.
- Do not over tighten the screws as this may cause damage to the TV and void your warranty.
- To prevent injury, this apparatus must be securely attached to the wall in accordance with the installation instructions.
- Use the screws and wall mounts that meet the following specifications. Any damages or injuries by misuse or using an improper accessory are not covered by the warranty.

For 50"/55"/65":

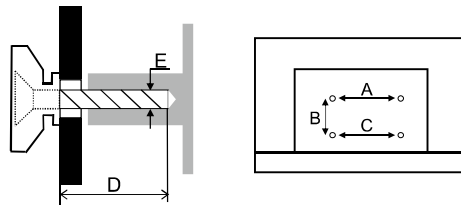

Model Size		50"		55"		65"		
		Top	Down	Top	Down	Top	Down	
Screw	Diameter(mm) "E"	M6	M6	M6	M6	M6	M6	
	Depth(mm) "D"	Max	15	15	15	15	28	28
		Min	10	10	10	10	22	22
Quantity		2	2	2	2	2	2	
A*B*C		200*200*200		200*200*200		400*200*400		

For 75":

Two wall mount columns (supplied with the TV) will be used with the top two wall mount holes to keep four wall mount screws fixed on the same horizontal surface.

Model Size		75"		
		Top	Down	
Screw	Diameter(mm) "E"	M6	M6	
	Depth(mm) "D"	Max	35	25
		Min	28	18
Quantity		2	2	
A*B*C		600*400*600		

Note:

1. The pictures are only for reference.
2. For the TV sets with terminals towards the wall, in order to leave enough space to use the terminals, a plastic spacer is needed together with each screw to fix the wall mount. It is a small hollow pillar, the height of which is $\geq 30\text{mm}$ (for 50"/55"/65") or the height of which is $\geq 15\text{mm}$ (for 75").

Precautions For Using Remote Control

- Use the remote control by pointing it towards the remote sensor. The items between the remote control and the remote sensor will interfere the normal operation.
- Do not make remote control vibrate violently. Also, do not splash liquid on the remote control, also do not put the remote control in high humidity place.
- Do not place remote control under direct sunlight which will cause deformation of the unit by heat.
- When the remote sensor is under direct sunlight or strong lighting, the remote control will not work. If so please change the lighting or TV's position, or operate the remote control closer to the remote sensor.
- Before Bluetooth searching, please make sure you have turned external Bluetooth devices in the pairing mode. For the Bluetooth remote control supplied with the TV (may not be available), you can press **BACK** and **HOME** buttons together to open its pairing mode. For other Bluetooth devices, please read their own instruction manuals for opening the pairing mode.

Precautions For Using Battery

Improper using of the battery will cause leakage. So please do as the following methods and use carefully.

1. Please note the batteries' polarity, to avoid short circuit.
2. When the battery's voltage is insufficient which affect the use range, you should replace new battery. Remove the batteries from the remote control unit if you do not intend to use it for a long time.
3. Do not use different types of batteries (for example, Manganese and Alkaline batteries) together.
4. Do not put the battery into fire, and charge or decompose the battery.
5. Please dispose of batteries in compliance with relevant environmental protection regulations.
6. WARNING: The batteries (battery pack or batteries installed) shall not be exposed to excessive heat such as sunshine, fire or the like.

Installation of Restraining Bracket (Only for some countries or models)

To prevent the TV from toppling over by some sudden circumstances like earthquake, shock, climbing by a child, etc., you are asked to install the restraining brackets before using the TV according to the following instructions and pictures:

- 1) Take out the accessories supplied with the TV from the package. (Pic.1)
 - TV Restraining Bracket: 2 PCS
 - TV Restraining Screw: M6 X 2PCS
 - Rope: 2 PCS
- 2) Use the TV restraining screws to fasten the TV restraining brackets on the TV rear cabinet. (Pic.1)
- 3) Fix the wall restraining brackets (bought by yourself) on the wall. (Pic.2)
- 4) Connect the TV restraining brackets and wall restraining brackets tightly with the ropes. (Pic.1 & Pic.2)

Note:

- 1) Please install the TV near the wall so that it doesn't fall backwards.
- 2) Please buy the wall restraining brackets (2pcs) and ropes (2pcs) by yourself as you need.
- 3) If the accessories does not have TV Restraining Brackets and TV Restraining Screws, it may be have installed on the TV.

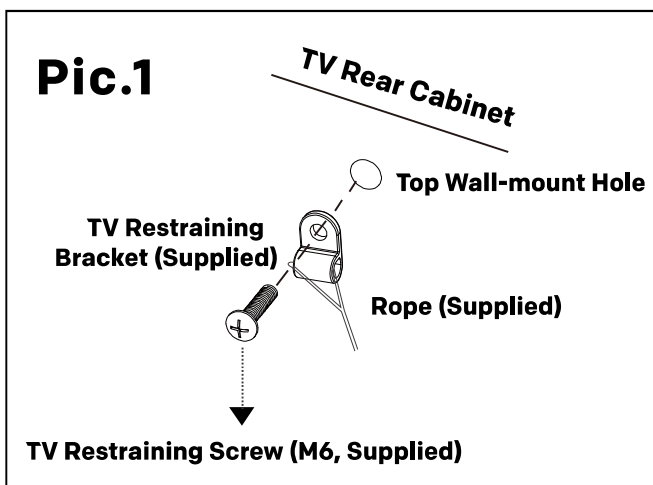
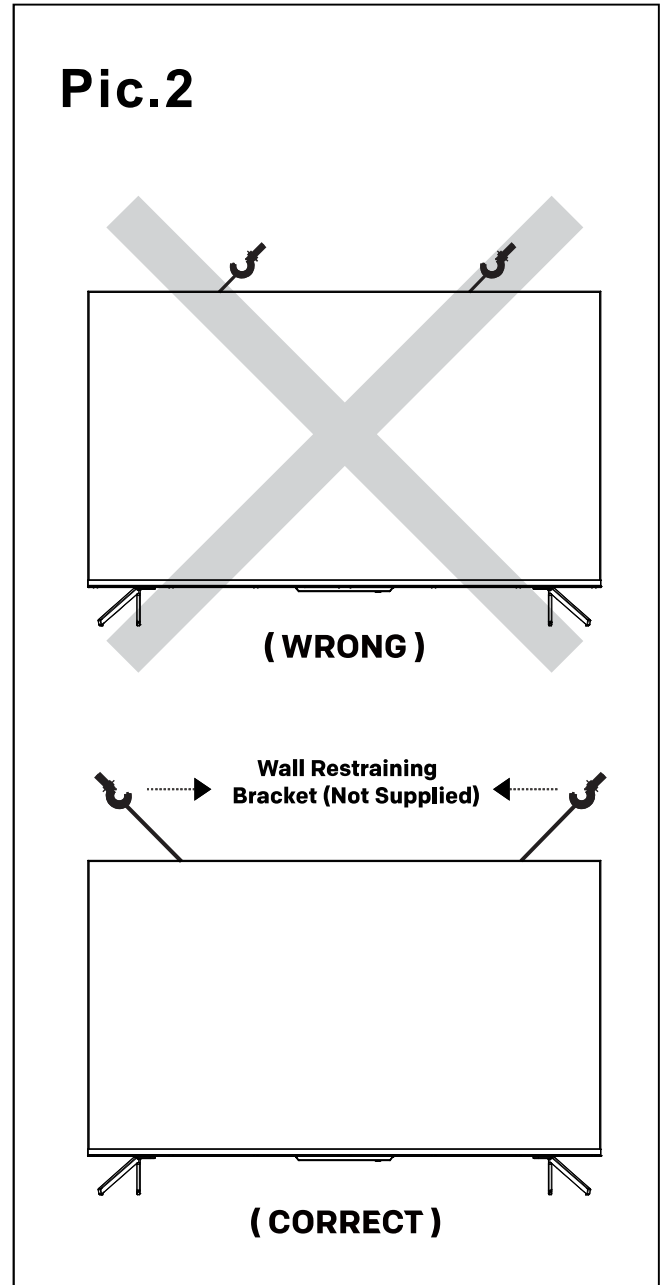

PREPARATION

Note: The pictures are only for reference.

Unpacking and Installation

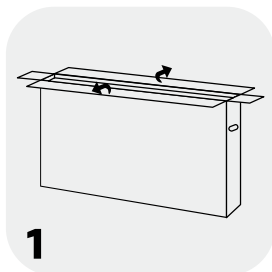

1

Open the package.

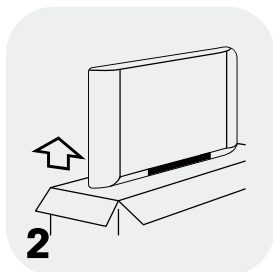

2

Take out the TV.



3

Install the TV stands.

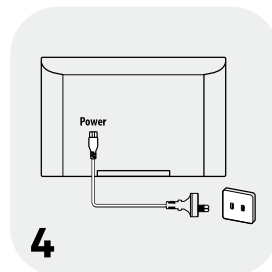

4

Connect the power cord.

Standard Accessories

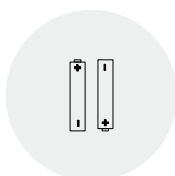

Batteries/2

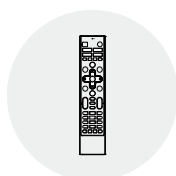

Remote Control



Power Cord



Stand Bases/2



Base Screws/4

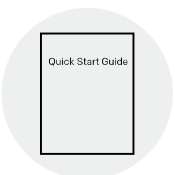

Quick Start Guide

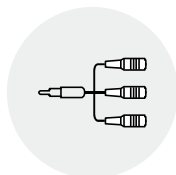

AV Converting Cable

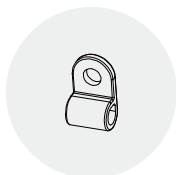

TV Restraining Brackets/2

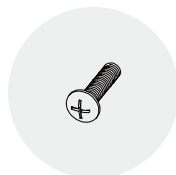

TV Restraining Screws/2



Ropes / 2

Stand Installation

Step 1: Take out the TV and carefully put it (screen downward) on a stable and flat table with a soft cloth or cushion on it.

Step 2: Please check to make sure there is the same mark(A/B) on the TV back and the correct stand. This step is not available for the stands without any mark on it, or not available for the TV with one stand only.

Step 3: Fix the stands to the TV by using the matching screws provided in the box. The stands may vary depending on the region or model.

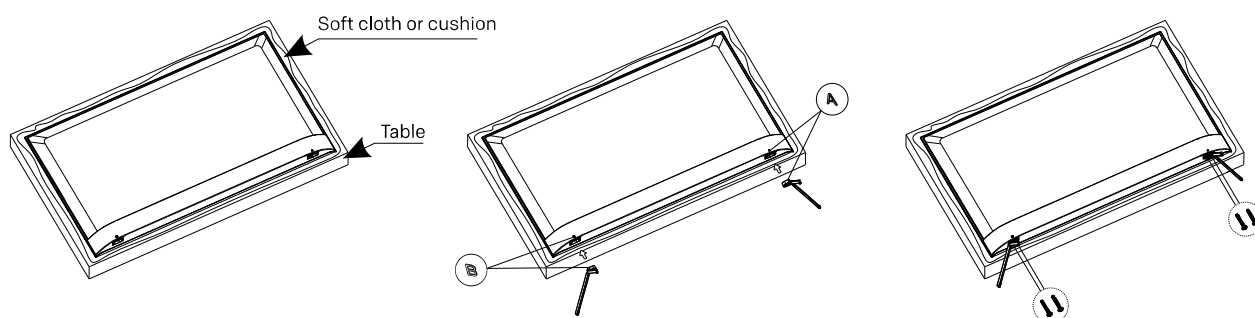

TERMINAL CONNECTION

Note:

- 1). The pictures are only for reference.
- 2). Terminal quantities and names may vary depending on the region or model.
- 3). External equipments and cables shown herein are not supplied with the TV.

• AV IN

Receive audio and video signals from external AV devices.

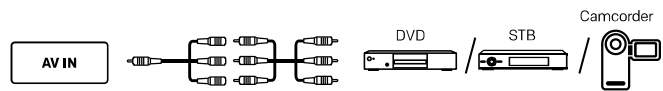

• ANTENNA IN

Connect a coaxial cable to receive signals from the antenna or cable.

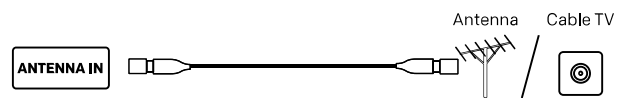

• USB

Connect a USB storage device.

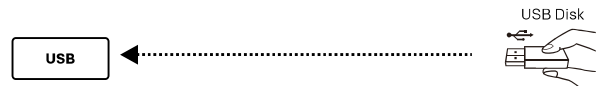

• HDMI

Receive 4K video input signal from HDMI devices such as DVD.

Note: HDMI1 supports ARC(Audio Return Channel) function, and you can connect ARC-enabled device with the TV by HDMI1 terminal.

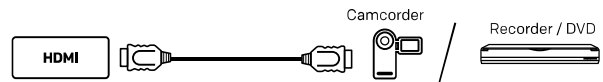

• DIGITAL AUDIO OUT

Use an optical cable to output your TV's audio signal to a compatible digital audio receiver.

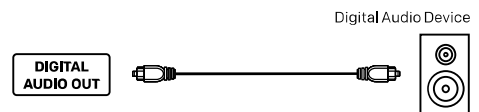

• LAN

Wired network port.



REMOTE CONTROL

Note:

1). The picture is only for reference.

2). The image, buttons and functions of remote control may vary depending on the region or model.

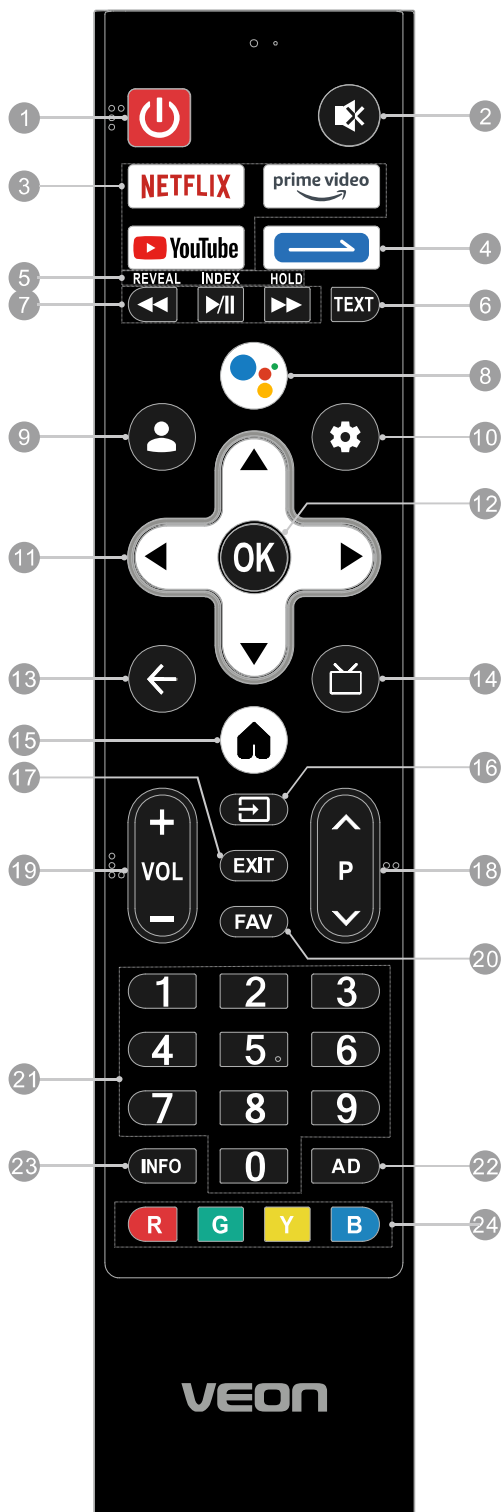

1. POWER (⏻): Turn the TV on or to standby mode.

2. MUTE (🔇): Mute or restore the TV sound.

3. Application Buttons: Access specific applications quickly and directly.

4. Compound Button:

- Short press to set or start the function of shortcut key.
- Long press to open the virtual keyboard including number buttons, color buttons, and so on.

5 & 6. *Teletext Buttons*****

- **REVEAL:** Display or hide the concealed information.
- **INDEX:** Display index page.
- **HOLD:** Hold the teletext page on screen without updates or changes.
- **TEXT:** Access or exit the teletext menu.

7. *Media Player Buttons*****

- **Play/Pause (▶/⏸):** Start or pause the playback.
- **Fast Backward (◀◀):** Fast backward the playback.
- **Fast Forward (▶▶):** Fast forward the playback.

8. MIC (🎤): Start using the near field voice function.

- Short press MIC button to wake up the voice assistant.
- Long press MIC button to start receiving your voice command. After your speaking, release MIC button to run voice function.

9. ACCOUNT (👤): Sign in with your Google account to get the entertainment you love.

10. Dashboard (⚙️): Access the dashboard of your Google TV.

11. UP/DOWN/LEFT/RIGHT (▲/▼/◀/▶)

Navigate the menu to select the content you need.

12. OK: Confirm, enter or execute the selected item, or show the list of Quick Button.

13. BACK (◀): Return to upper-level content, or exit the current screen.

14. GUIDE (📺): Access the Electronic Program Guide in DTV mode.

15. HOME (🏠): Access the home screen.

16. SOURCE (📺): Access the source menu.

17. EXIT: Exit the current operation.

18. Program Up/Down (P ▲/▼): Switch channels.

19. Volume Up/Down (VOL +/-): Adjust the sound volume.

20. FAV: Access the list of favorite channels.

21. Number Buttons (0~9):

Select the channel directly, or input a number.

22. AD: Turn on or turn off the function of audio description.

23. INFO: Access the INFO interface.

24. Color Buttons (R/G/Y/B):

Execute the prompt function in specific mode.

VOICE FUNCTION

Note:

- 1). The pictures are only for reference.
- 2). The colour of indicators lit in various modes or circumstances may vary depending on the region or model.
- 3). The voice function may not be available depending on the region, model or language.

Far Field Voice

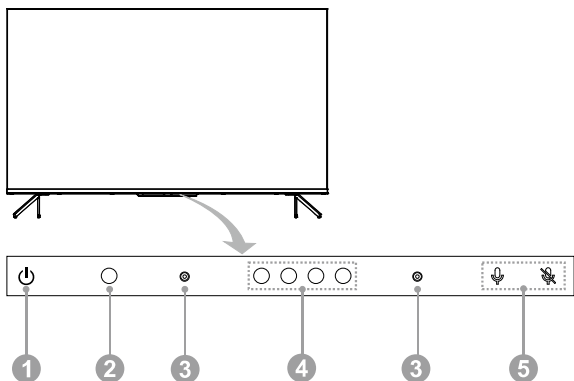

1. TV Control Button (Located under this icon)

* In standby mode:

Short press TV control button to turn on the TV.

* In working status:

Short press TV control button to call out the following menu of soft keyboard. Inside it, short press TV control button to move the cursor and select the desired item. Long press TV control button to enter or execute the selected item.

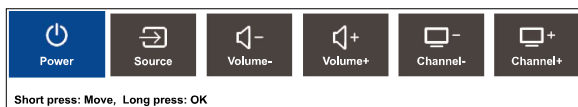

2. Power Indicator

Indicate the status of the TV power.

* Unlit / Lit in green: working mode.

* Lit in red: standby mode.

* Unlit: power off.

3. Far Field Microphone

Microphones of far field voice function. It is best to keep yourself within 3 meters away from the far field microphones while using the far field voice function.

4. Far Field Indicator

Indicate the status of far field microphones and far field voice function.

* Lit in white: far field microphones are turned on, and far field voice function is being used.

* Unlit: far field microphones are turned on, but far field voice function is not being used.

* Lit in orange: far field microphones are turned off.

5. Switch of Far Field Microphones (Located under these icons)

Turn on or turn off the microphones of far field voice function. Only after turning on the far field microphones, successfully connecting your TV to the network and signing in to your Google account, you can start to use the far field voice function by saying the hotword: "Ok Google" or "Hey Google".

Near Field Voice

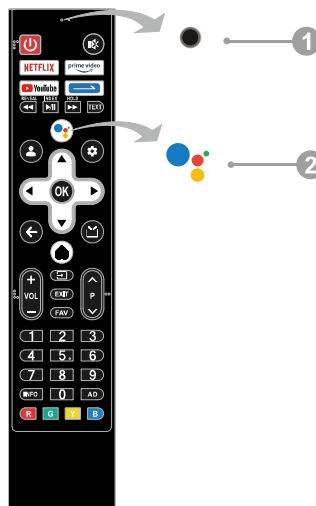

1. Near Field Microphone

Microphone of near field voice function.

It is best to keep your mouth within 5 centimeters away from the near field microphone while using the near field voice function.

2. MIC Button of Near Field Voice Function

Press to start using the near field voice function. Only after successfully connecting your TV to the network, pairing the Bluetooth remote control with your TV and signing in to your Google account, you can press MIC button to start using the near field voice function.

< Pair Bluetooth remote control with your TV >

For the remote control supplied with your TV, please finish pairing with your TV before using it for near field voice function. The pairing could be done at the first step of "Initial Setup", or in "Settings".

In settings, please refer to the following steps to pair the remote control:

1. Select "**Dashboard** button → Settings → Remotes & accessories".
2. Press **BACK** and **HOME** buttons simultaneously until there shows the name of your Bluetooth remote control on the TV searching interface.
3. Press **OK** button to start pairing.
4. It will show "Paired" after Bluetooth remote control is paired with the TV successfully.

BASIC OPERATION

E-Manual

E-Manual is built into your TV and can be displayed on the screen. To learn more about your TV features, access the E-Manual by referring to the following operation.

E-Manual may not be available depending on the region or model.

1. Press **HOME** button to access the home screen.
2. Press **▲/▼/◀/▶** and **OK** button to select and enter "E-Manual" in the app list.

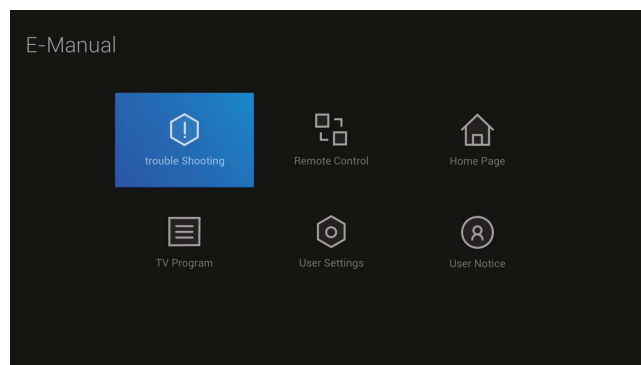

Note: The picture is only for reference.

Install Remote Control Batteries

Place two AAA size batteries in the remote control's battery compartment, making sure to match the polarity markings inside the compartment.

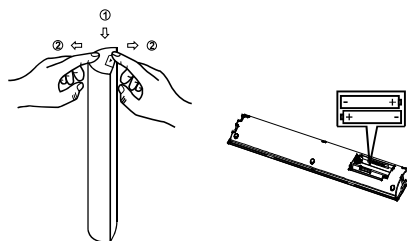

Note: The picture is only for reference.

TROUBLE SHOOTING

Before calling a service technician, please check the following table for a possible cause of the symptom and some solutions.

General Problem / Solution

- **Remote control does not work**
Change the batteries.
Check if batteries are installed correctly.
Check if main power is connected.
Check if there are some items between remote sensor and remote control.
- **Poor Signal**
This is usually caused by interference from electronic equipments or radio interference sources.

Picture & Sound / Solution

- **No picture, no sound**
Check the signal source.
Plug another electrical device into the outlet to check if it is working or turned on.
Check if power plug is in good contact with the outlet.
- **No sound, picture OK**
If no sound, unmute the sound or increase the volume.
Open the sound menu and adjust 'Balance'.
- **Abnormal picture**
For no color or bad picture quality, you may:
 1. Adjust the color option in menu settings.
 2. Keep the TV at a sufficient distance from other electronic products.
 3. Try another channel.Bad TV signal (Display mosaic or snowflakes)
 1. Check the signal cable and adjust the antenna.
 2. Fine tune the channel.
 3. Try another channel.
- **No 4k UHD Video or No Signal from HDMI source**
Check which HDMI port connected with your device and select from SOURCE.
Check the device is powered on which connected on the selected HDMI port.
Check TV HDMI port EDID setting, go to Settings/Channels & Inputs/Inputs/HDMI EDID version, ensure the EDID setting is same as your connected device.
Ensure your HDMI cable support 4K UHD video.
Disconnect HDMI cable and connect again.

Multimedia Player / Solution

- **'This file is invalid' /'Unsupported audio' appears , or audio is normal but video is abnormal, or video is normal but audio is abnormal**
The media file maybe damaged, check if the file can be played on the PC.
Check if video and audio codec is supported.

Network / Solution

- **Network failure**
Check if the router works well.
Make sure the TV has connected to the router successfully.

Browser / Solution

- **Web page can not be displayed completely**
Some third-party extensions of the current web page may not be supported, and please close the current web page.
- **Browser is forced to be shut down**
The current web page may include too many contents which cause there isn't sufficient memory and the browser is closed.

SPECIFICATION

Working voltage:	100-240V~ 50/60 Hz
Dimensions without stand (W X H X D):	50": 1110 X 651 X 90 mm 55": 1225 X 720 X 93 mm 65": 1445 X 838 X 97 mm 75": 1668 X 965 X 84 mm
Net weight without stand:	50": 8.9 kg 55": 10.7 kg 65": 17.8 kg 75": 28.8 kg
RF aerial input:	75 ohm unbalanced
Language of OSD:	Multiple options
System:	DTV: DVB - T/T2/C ATV: PAL BG/I/DK
Channel coverage:	DVB-T/T2: 174 MHz ~ 230 MHz, 470 MHz ~ 860 MHz DVB-C: 48 MHz ~ 859 MHz ATV: 47.25 MHz ~ 865.25 MHz
Environment:	Working temperature: 5°C~40°C Working humidity: 20%~80% Storage temperature: -15°C~45°C Storage humidity: 10%~90%, non-condensing

Note:

Some specifications may differ by different regions or models, and please take your actual TV set as the standard.

LICENSE



Google TV is the name of this device's software experience and a trademark of Google LLC. Google, YouTube, and Chromecast built-in and other related marks are trademarks of Google LLC.



The Adopted Trademarks HDMI, HDMI High-Definition Multimedia Interface, and the HDMI Logo are trademarks or registered trademarks of HDMI Licensing Administrator, Inc. in the United States and other countries.



For DTS patents, see <http://patents.dts.com>. Manufactured under license from DTS, Inc. (for companies headquartered in the U.S./Japan/Taiwan) or under license from DTS Licensing Limited (for all other companies). DTS, DTS Studio Sound, and the DTS logo are registered trademarks or trademarks of DTS, Inc. in the United States and other countries. © 2021 DTS, Inc. ALL RIGHTS RESERVED.



Manufactured under license from Dolby Laboratories. Dolby, Dolby Audio, and the double-D symbol are trademarks of Dolby Laboratories Licensing Corporation.

Note:

- 1. The pictures in this document are only for reference.*
- 2. Appearances and specifications are subject to change without notice.*
- 3. In dry environment due to static electricity, the product may restart and return to the main OSD interface, USB player interface or the previous source mode. It is normal and please continue to operate the TV as you will.*

Three Year WARRANTY

We pride ourselves on producing a range of quality home products that are both packed with features and completely reliable. We are so confident in our products, we back them up with a three years warranty. Now you too can relax knowing that you are covered. Customer Helpline NZ: 0800 883 301.

This Product is covered by three years warranty when accompanied by proof of purchase.



WARRANTY CARD

This product is guaranteed against faulty materials and workmanship for a period of **three years** from the date of purchase with proof of purchase. Under this warranty, the warrantor's obligation to the purchaser is to remedy manufacturing faults by repairing or replacing faulty parts or, if unable to be remedied, replacing or refunding the product with proof of purchase. This warranty becomes void if the product has been tampered with or damaged in any other way by improper use. This product has been quality inspected. In the unlikely event of a deficiency, please contact the retailer from which this product was purchased.

WARRANTY FOR PRODUCTS USED COMMERCIALY LIMITED TO 90 DAYS

Please fill this in upon purchase in case you lose your receipt.

Model Number: _____

Serial Number: _____

Date of Purchase: _____

Receipt Number: _____

Store Purchased from: _____

IMPORTANT

Please retain this warranty card along with your purchase receipt. Please do not post to the retailer or importer. If service is required, both of these documents are to be returned with the product to your retailer, otherwise a fee may be charged.

Customer support line 0800 883 301

For assistance during normal working hours
Monday – Friday, 9am – 5pm, New Zealand local time