



POWER STEEL™ RECTANGULAR FRAME POOLS OWNER'S MANUAL

www.bestwaycorp.com

Visit Bestway YouTube channel 





WARNING

smooth out the bottom

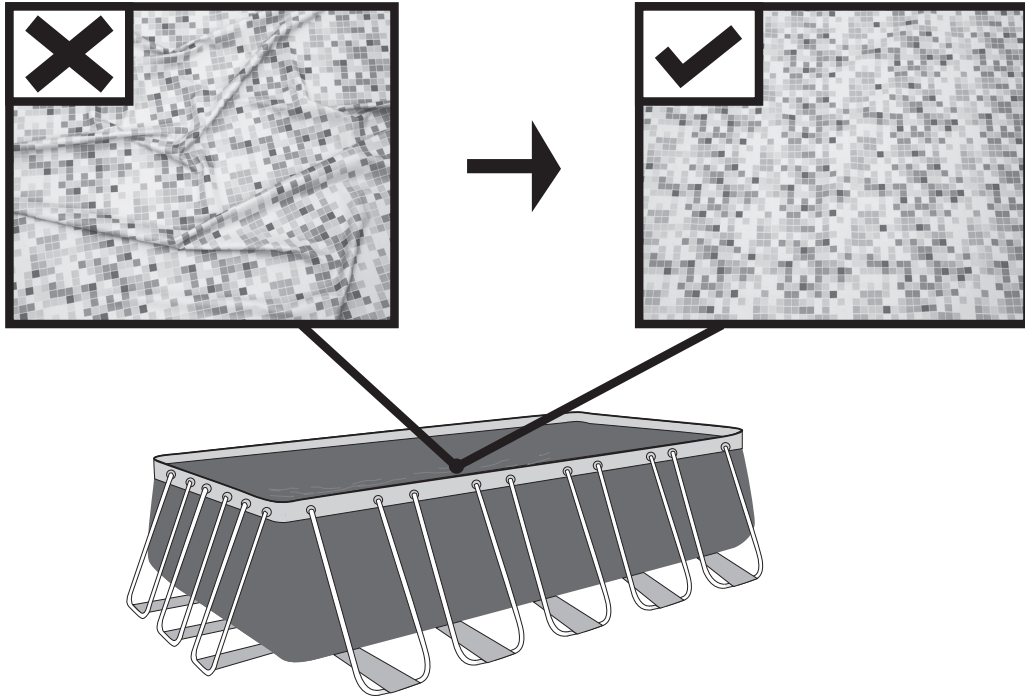

Put 1" to 2" water in the pool to cover the floor. Once pool floor is slightly covered, gently smooth out all wrinkles. Start in the center of the pool and work your way clockwise to the outside.

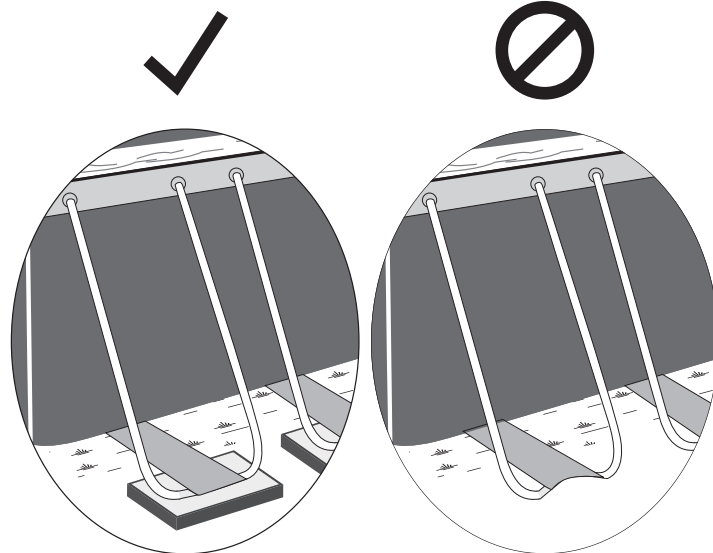

Do not assemble on soft lawn. If you must assemble the pool on a soft surface, timber boards must be placed under the feet of the vertical supports to spread the load.

WARNING

Carefully read, understand, and follow all information in this user manual before installing and using the swimming pool. These warnings, instructions, and safety guidelines address some common risks of water recreation, but they cannot cover all risks and dangers in all cases. Always use caution, common sense, and good judgment when enjoying any water activity. Retain this information for future use.

Non Swimmers safety

- Continuous, active, and vigilant supervision of weak swimmers and non-swimmers by a competent adult is required at all times (remembering that children under five are at the highest risk of drowning).
- Designate a competent adult to supervise the pool each time it is being used.
- Weak swimmers or non-swimmers should wear personal protection equipment when using the pool.
- When the pool is not in use, or unsupervised, remove all toys from the swimming pool and its surrounding to avoid attracting children to the pool.

Safety devices

- In order to prevent children from drowning, it is recommended to secure the access to the pool with a protection device. In order to prevent children climbing from the inlet and outlet valve, it is recommended to install a barrier (and secure all doors and windows, where applicable) to prevent unauthorized access to the swimming pool.
- Barriers, pool covers, pool alarms, or similar safety devices are helpful aids, but they are not substitutes for continuous and competent adult supervision.

Safety equipment

- It is recommended to keep rescue equipment (e.g. a ring buoy) by the pool.
- Keep a working phone and a list of emergency phone numbers near the pool.

Safe use of the pool

- Encourage all users especially children to learn how to swim
- Learn Basic Life Support (Cardiopulmonary Resuscitation - CPR) and refresh this knowledge regularly. This can make a life-saving difference in the event of an emergency.
- Instruct all pool users, including children, what to do in case of an emergency
- Never dive into any shallow body of water. This can lead to serious injury or death.
- Do not use the swimming pool when using alcohol or medication that may impair your ability to safely use the pool.
- When pool covers are used, remove them completely from the water surface before entering the pool.
- Protect pool occupants from water related illnesses by keeping the pool water treated and practicing good hygiene. Consult the water treatment guidelines in the user's manual.
- Store chemicals (e.g. water treatment, cleaning or disinfection products) out of the reach of children.
- Use the signage as outlined below. Signage is to be displayed in a prominent position within 2m of the pool.



Keep children under supervision in the aquatic environment. No diving.

- Removable ladders shall be placed on a horizontal surface.
- Irrespective of materials used for swimming pool construction, accessible surfaces have to be checked regularly to avoid injuries.
- Regularly monitor bolts and screws. Remove splinters or any sharp edges to avoid injuries.
- **ATTENTION:** Do not leave the drained pool outside. The empty pool is liable to become deformed and/or displaced due to wind.

- If you have a filter pump, refer to the pump's manual for instructions.

- **WARNING!** The pump cannot be used while people are inside the pool!

- If you have a ladder, refer to the ladder's manual for instructions.
- **WARNING!** The use of a swimming pool implies compliance with the safety instructions described in the operating and maintenance guide. In order to prevent drowning or other serious injuries, pay particular attention to the possibility of unexpected access to the swimming pool by children under 5 years by securing the access to it, and, during the bathing period, keep them under constant adult supervision.

Installation usually takes approximately 20-30 minutes with 2-3 people excluding earthworks and filling.





See below for part descriptions.

Components list:

NOTE: Some parts already have been installed on the pool.





Size of pool	U-Support A		U-Support B		57 Top Rail Spring-Loaded Pin		48 Top Rail Spring-Loaded Pin		No. of Top Rail											
	QTY		QTY		QTY		QTY		A		B		C		D		E		F	
	Part No.	Part No.	Part No.	Part No.	Part No.	Part No.	Part No.	Part No.	Part No.	Part No.	Part No.	Part No.	Part No.	Part No.	Part No.	Part No.	Part No.	Part No.	Part No.	Part No.
2.82mx1.96mx84cm (11'x7'x33")	4	P61573	4	P61574	/	/	4	P61364	2	P61356	2	P61357	2	P61358	2	P61359	/	/	/	/
4.04mx2.01mx1.00m (15'9"x79"x39.5")	6	P61362	4	P61363	/	/	6	P61364	2	P61356	2	P61357	2	P61358	2	P61359	2	P61360	/	/
4.12mx2.01mx1.22m (16'2"x79"x48")	6	P61368	4	P61369	/	/	6	P61364	2	P61356	2	P61357	2	P61358	2	P61359	2	P61360	/	/
4.88mx2.74mx1.22m (16'x9'x48")	12	P61283	/	/	8	P61284	/	/	/	/	/	/	/	/	4	P61280	4	P61281	4	P61370
4.88mx4.88mx1.22m (16'x16'x48")	16	P61283	/	/	12	P61284	/	/	/	/	/	/	/	/	4	P61280	8	P61281	4	P61370
5.49mx2.74mx1.22m (18'x9'x48")	12	P61283	/	/	8	P61284	/	/	4	P61277	2	P61278	2	P61279	2	P61280	2	P61281	/	/
6.71mx3.66mx1.32m (22'x12'x52")	16	P61392	/	/	12	P61284	/	/	6	P61277	2	P61278	2	P61279	2	P61389	2	P61390	2	P61391
7.32mx3.66mx1.32m (24'x12'x52")	18	P61392	/	/	14	P61284	/	/	8	P61371	2	P61372	2	P61373	2	P61389	2	P61390	2	P61391
9.56mx4.88mx1.32m (31.3'x16'x52")	24	P61392	/	/	20	P61284	/	/	12	P61371	2	P61372	2	P61373	2	P61280	2	P61281	4	P61370

Below parts are for all sizes of pool.

#01	#02	#03	#04
 x1	 x4	 x1	 x1
Liner	Underwater Adhesive repair patch	Hose Adaptor	Drain Valve Cap
Please refer to below table	#F1B417	#P6H1419	#P6H1158



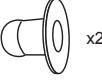



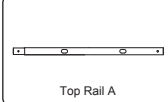
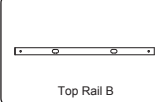
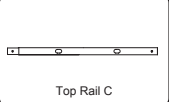
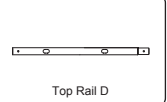
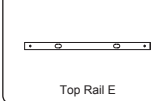
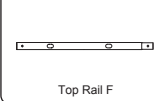
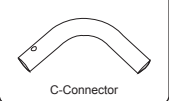

2.82mx1.96mx84cm/11'x7'x33"
4.04mx2.01mx1.00m/15'9"x39.5"
4.12mx2.01mx1.22m/16'2"x79"x48"
4.88mx2.74mx1.22m/16'x9'x48"

4.88mx4.88mx1.22m/16'x16'x48"
5.49mx2.74mx1.22m/18'x9'x48"
6.71mx3.66mx1.32m/22'x12'x52"
7.32mx3.66mx1.32m/24'x12'x52"
9.56mx4.88mx1.32m/31.3'x16'x52"

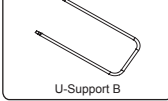
#05	#06	#07	#08
 x3	 x1	 x2	 x1
Stopper	Control Valve	Stopper	Pool inlet Strainer
#P6H1418	#P6H510	#P6H1418	#P6H1317

NO.	Name	QTY	Part NO.	Remark	
#01	Liner	1	56631ASS17	#56631	2.82mx1.96mx84cm/11'x7'x33"
			56426ASS17	#56426	4.04mx2.01mx1.00m/15'9"x39.5"
				#56660	
			56458ASS17	#56458	4.12mx2.01mx1.22m/16'2"x79"x48"
				#56661	
			56489ASS17	#56489	4.88mx2.74mx1.22m/16'x9'x48"
				#56380	
			56628ASS17	#56628	4.88mx4.88mx1.22m/16'x16'x48"
				#56467	
			56467ASS17	#56468	5.49mx2.74mx1.22m/18'x9'x48"
				#56473	
			56473ASS17	#56662	6.71mx3.66mx1.32m/22'x12'x52"
				#56476	
			56476ASS17	#56477	7.32mx3.66mx1.32m/24'x12'x52"
	#56480				
56480ASS17	#56625	9.56mx4.88mx1.32m/31.3'x16'x52"			

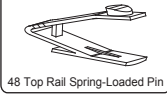
Below parts are for steel frame of pool.

 Top Rail A	 Top Rail B	 Top Rail C	 Top Rail D
 Top Rail E	 Top Rail F	 C-Connector	 U-Support A
 U-Support B	 57 Top Rail Spring-Loaded Pin	 U-Support Spring-loaded Pin	 Small U-Support Cap
 Sleeve for C-connector	 48 Top Rail Spring-Loaded Pin	 Big U-Support Cap	

Size of pool	C-Connector		U-Support Spring-loaded Pin		Small U-Support Cap		Big U-Support Cap		Sleeve for C-connector	
	QTY	Part No.	QTY	Part No.	QTY	Part No.	QTY	Part No.	QTY	Part No.
2.82mx1.96mx84cm (111"x77"x33")	4	P61361	16	P61366	16	P61367	/	/	8	P61365
4.04mx2.01mx1.00m (159"x79"x39.5")	4	P61361	20	P61366	20	P61367	/	/	8	P61365
4.12mx2.01mx1.22m (162"x79"x48")	4	P61361	20	P61366	20	P61367	/	/	8	P61365
4.88mx2.74mx1.22m (16"x9"x48")	4	P61282	24	P61286	/	/	24	P61287	8	P61285
4.88mx4.88mx1.22m (16"x16"x48")	4	P61282	32	P61286	/	/	32	P61287	8	P61285
5.49mx2.74mx1.22m (18"x9"x48")	4	P61282	24	P61286	/	/	24	P61287	8	P61285
6.71mx3.66mx1.32m (22"x12"x52")	4	P61282	32	P61286	/	/	32	P61287	8	P61285
7.32mx3.66mx1.32m (24"x12"x52")	4	P61282	36	P61286	/	/	36	P61287	8	P61285
9.56mx4.88mx1.32m (31.3"x16"x52")	4	P61282	48	P61286	/	/	48	P61287	8	P61285

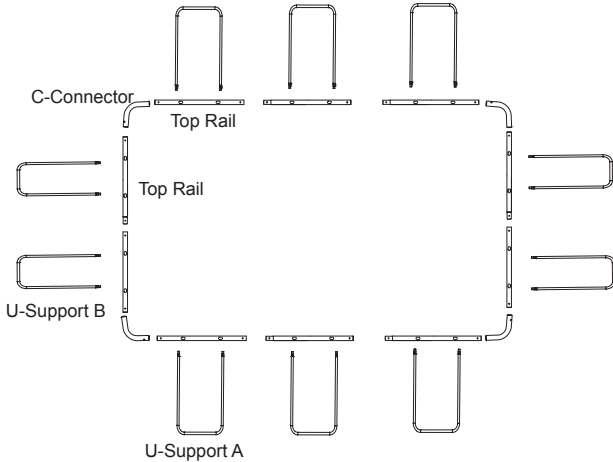

NOTE: Drawing only for (111" x 77" x 33"), (159" x 79" x 39.5"), (162" x 79" x 48") Size of Pool.
NOTE: Drawing for illustration purpose only. May not reflect actual product. Not to scale.

Size of pool	No. of U-shaped support	Top Rail Combinations		No. of Top Rail						C-Connector
		Long Side	Short Side	A	B	C	D	E	F	
2.82mx1.96mx84cm (111"x77"x33")	8	B-A	C-D	2	2	2	2	0	0	4
4.04mx2.01mx1.00m (159"x79"x39.5")	10	B-E-A	C-D	2	2	2	2	2	0	4
4.12mx2.01mx1.22m (162"x79"x48")	10	B-E-A	C-D	2	2	2	2	2	0	4
4.88mx2.74mx1.22m (16"x9"x48")	12	D-F-F-E	D-E	0	0	0	4	4	4	4
4.88mx4.88mx1.22m (16"x16"x48")	16	D-F-F-E	D-F-F-E	0	0	0	4	8	4	4
5.49mx2.74mx1.22m (18"x9"x48")	12	B-A-A-C	D-E	4	2	2	2	2	0	4
6.71mx3.66mx1.32m (22"x12"x52")	16	B-A-A-A-C	E-D-F	6	2	2	2	2	2	4
7.32mx3.66mx1.32m (24"x12"x52")	18	B-A-A-A-A-C	E-D-F	8	2	2	2	2	2	4
9.56mx4.88mx1.32m (31.3"x16"x52")	24	B-A-A-A-A-A-C	D-F-F-E	12	2	2	2	2	4	4

PLEASE READ CAREFULLY AND RETAIN FOR FUTURE REFERENCE.

CHOOSE THE CORRECT LOCATION

NOTE: The pool must be set up on a completely flat and level surface. Please do not install the pool if the surface is inclined or sloped.

Correct conditions to set up the pool:

- The selected location has to be capable of uniformly supporting the weight for the entire time the pool is installed, moreover the location must be flat and must be cleared of all objects and debris including stones and twigs.
- We recommend positioning the pool away from any objects children could use to climb into the pool.
- NOTE: Position the pool near an adequate drainage system to deal with overflow or to discharge the pool.**

Incorrect conditions to set up the pool:

- On uneven ground the pool may collapse causing serious personal injury and/or damage to personal property and will void the warranty and prevent any service claims.
- Sand should not be used to create a level base; the ground must be dug out if necessary.
- Directly under overhead power lines or trees. Be sure the location does not contain underground utility pipes, lines or cables of any kind.
- Do not set up the pool on driveways, decks, platforms, gravel or asphalt surfaces. The selected location should be firm enough to withstand the pressure of the water; Mud, sand, soft / loose soil or tar are not suitable.
- Grass or other vegetation under the pool will die and may cause odors and slime to develop, therefore we recommend removing all grass from the selected pool location.
- Avoid areas prone to aggressive plant and weed species that may grow through the ground cloth or liner.

NOTE: Check with your local city council for by-laws relating to fencing, barriers, lighting and safety requirements and ensure you comply with all laws.

NOTE: If have a filter pump, refer to the pump's manual for instructions.

NOTE: The ladder must match the pool size and should be used only for entering and exiting the pool. It is forbidden to exceed the permitted payload of the ladder. Check regularly if the ladder is properly assembled.

Installation

Assembly of the Rectangular Frame Pool can be completed without tools.

Bestway Inflatables will not be responsible for damage caused to the pool due to mishandling or failure to follow these instructions.

- Lay out all parts and check that you have the correct quantities as listed in the components list. If you are missing any part do not assemble the pool, contact Bestway Customers Service.
- Spread out the pool and make sure the pool is right side up, let it sit exposed to direct sunlight for 1 hour or more so that the pool is more flexible during set up.
- Place the pool near an adequate drainage system to deal with overflow water and ensure the pool's inlet A and outlet B are correctly positioned to allow your filter pump to connect to a power source. **NOTE: Do not use extension power cords to power your pump.**
ATTENTION: Do not drag the pool on the ground, this can damage the pool.
- Insert the stopper plugs into inlet A and outlet B on the wall from the inside of the pool.
NOTE: For pool with connection valve, please refer to the connection valve installation on following page.
- Assemble the Top Rails. Start with the long side of the pool, begin by sliding Top Rail B into the pool sleeve. Connect Top Rail A or Top Rail E to Top Rail B, ensure the spring-loaded pins snap into the pre-drilled holes. Be sure to reference the Top Rail Combination Chart to determine the correct configuration for your pool. Continue connecting and inserting additional Top Rails. Be sure to line up the holes in the rails with the holes on the sleeves. (See Fig.1)
- Insert the C-Connectors into the Top Rails. (See Fig. 2.1/2.2)
- Install the U-Support; first insert the U-Support through the Pole Support at the bottom of the pool (See Fig. 3.1/3.2), then insert the two ends of the U-Support into the exposed holes on the Top Rail (See Fig. 3.3), ensure the spring-loaded pins snap into position. Repeat this procedure for the remaining U-Supports.
NOTE: Complete one side of the pool before moving to the other side.
- Pull the bottoms of the U-Support outward away from the liner and make the Pole Support taut. Repeat this procedure for remaining U-Supports.
- Ensure drain valve is firmly closed.
- Put 1" to 2" (2.5cm to 5cm) water in the pool to cover the floor. Once pool floor is slightly covered, gently smooth out all wrinkles. Start in the center of the pool and work your way clockwise to the outside. (See Fig.4)

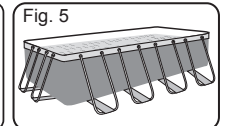
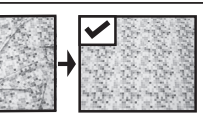
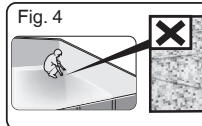
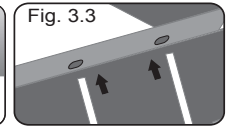
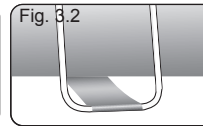
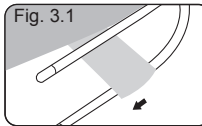
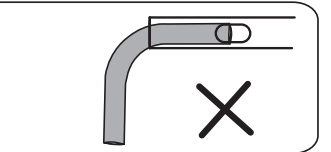
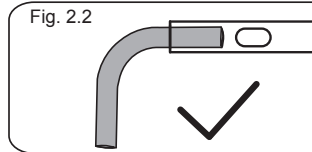
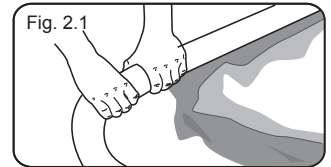
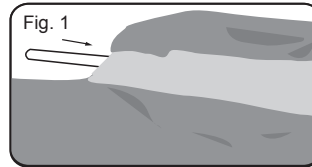

Connection Valve Assembly

For pool with connection valve (See Fig.6)

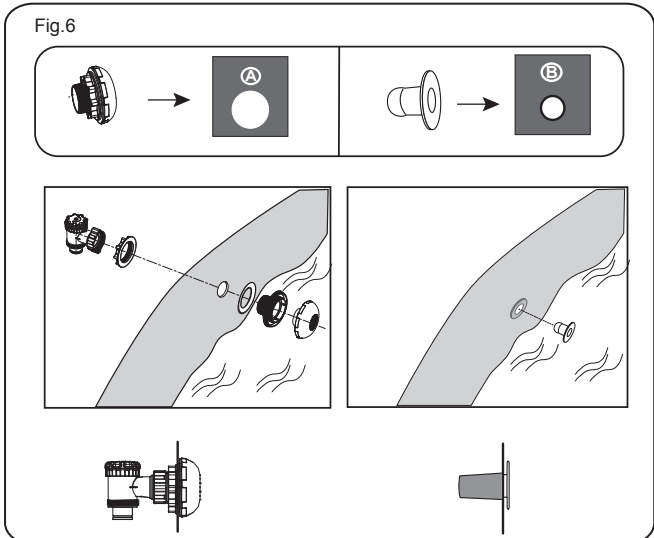

Filling Pool with Water

ATTENTION: Do not leave pool unattended while filling with water.

1. Fill pool until water capacity is 90%, DO NOT OVERFILL as this could cause the pool to collapse. In times of heavy rainfall you may need to empty some of the water to ensure the level is correct. (See Fig. 7)
2. When filling the pool is completed, check that the water is not collecting on any side to ensure the pool is level.
IMPORTANT: If pool is not level, drain water and re-level ground by digging out (See Fig. 8). Never attempt to move the pool with water in it, serious personal injury or damage to the pool may result.
WARNING: Your pool may contain a great deal of pressure. If your pool has any bulge or uneven side then the pool is not level, the sides may burst and the water may discharge suddenly causing serious personal injury and/or damage to property.
3. Check pool for any leaks at valves or seams, check ground cloth for any evident water loss. Do not add chemicals until this has been done.
NOTE: In the event of a leak, patch your pool using the underwater adhesive repair patch provided. Refer to the FAQ's for further information.

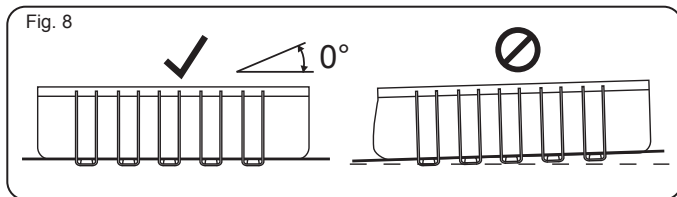
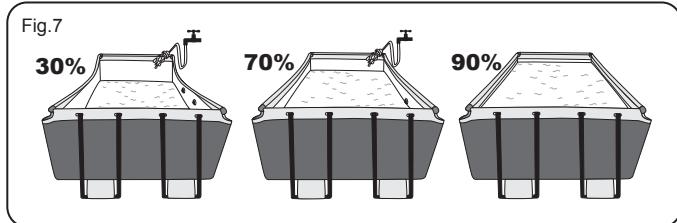

Pool Maintenance

If you do not adhere to the maintenance guidelines below, your health might be at risk, especially that of your children.

IMPORTANT: If you don't respect the ideal values of the water chemicals the PVC can be damaged and become discolored.

The following table lists the sequence of the tests that should be carried out for the ideal values and possible actions. Regularly check the pH value and chlorine concentration weekly and adjust to the ideal values.

TEST	IDEAL VALUES
pH value	7.4 – 7.6
Cyanuric acid	30 – 50 ppm
Free chlorine	2 – 4 ppm
Chlorine compound	0
Algae	None visible
Calcium hardness	200 – 400 ppm

To keep your pool clean:

1. Contact your local pool supply shop for advice and purchase of chemicals and pH kits. One of the most important factors to increase the life of the liner is to keep continuously clean and healthy water. Please strictly follow the instructions from professional technicians for the water treatment through the use of chemicals.
2. Locate a bucket of water next to pool to clean users' feet before entering pool.
3. Cover the pool when not in use.
4. Skim pool regularly to avoid settled dirt.
5. Check and wash the filter cartridge regularly.
6. Gently clean any scum from below the top ring with a clean cloth.
7. Please be careful in case of rain water, kindly check that the water level is not higher than the expected. If so, YOU HAVE TO DISCHARGE THE EXCESS WATER

Proper maintenance can maximize the life of your pool.

During the season of use of the swimming pool, the filtration system must be necessarily put into service every day, enough time to assure at least a complete renewal of the volume of water.

ATTENTION: Do not use pump when pool is in use.

During the season of use of the swimming pool, the filtration system must be necessarily put into service every day, enough for a long time to assure at least a complete renewal of the volume of water.

Repair

Check pool for any leaks from valves or seams, check the ground cloth for any evident water loss. Do not add chemicals until this has been done.

NOTE: In the event of a leak, patch your pool using the Heavy-duty repair patch provided. Refer to the FAQs for further information.

Dismantling

1. Unscrew the drain valve cap on the outside of the pool counter clockwise and remove.
2. Connect the adaptor to the hose and put the other end of the hose in the area where you are going to drain your pool. (Check local regulations for drainage by-laws).
3. Screw the control ring of the hose adaptor clockwise onto the drain valve. The drain valve will be open and water will start to drain automatically.
ATTENTION: Water flow can be controlled with the control ring.
4. When draining is finished, unscrew the control ring to close the valve.
5. Disconnect the hose.
6. Screw the cap back onto the drain valve.
7. Air dry pool.

ATTENTION: Do not leave the drained pool outside.

Storage and Winterization

1. Please remove all the accessories and spare parts of the pool and store them clean and dry.
2. Once pool is completely dry, sprinkle with talcum powder to prevent pool from sticking together, fold pool carefully.
If pool is not completely dry, mold may result and will damage the pool liner.
3. Store liner and accessories in a dry place with a moderate temperature between 5°C / 41°F and 38°C / 100°F.
4. During the rainy season, pool and accessories should be stored as per above instructions also.
5. Improper draining of the pool might cause serious personal injury and/or damage to personal property.
6. We strongly recommend the pool is disassembled during the off season (winter months). Store in a dry location out of children's reach

Frequently Asked Questions

1. What is a suitable base for the Rectangular Frame pool?

Almost any completely flat, solid, level surface can be used. Do not use sand as a leveling material as it is prone to shifting under the pool. The ground should be dug out until it is perfectly level. Do not set up on driveways, decks, platforms, gravel or asphalt. The ground should be firm enough to withstand the weight and pressure of the water: mud, sand, soft / loose soil or tar are not suitable. A concrete base can be used but care should be taken not to drag the pool across the surface as abrasions could tear the liner. If the pool is to be set up on a lawn, it is recommended that the grass is removed from where the pool will sit as it will die and may cause odors / slime. Certain types of hardy grass can grow through the liner as can aggressive bushes / plants by the side of the pool. Ensure adjacent vegetation is cut back where necessary. Use of a ground cloth assists in protecting the base of the pool.

2. How will I know if my pool is set up on unlevelled ground?

If your pool appears to be bulging on one side it is not set up on level ground. It is important that you empty your pool and move the pool to a level site. If the pool is not on level ground it will place undue stress on the seams and could result in the seams bursting which will cause flooding, property damage and potentially personal injury or death.

Fill your pool following the instructions in the owner's manual carefully. This will ensure that you do not waste water and the pool can be moved easily so that the ground can be leveled at an appropriate time and not after you have completely filled it with water.

3. Can I have my pool filled by a water service?

We recommend using a garden hose under low pressure for filling your pool. If it is necessary to use a water delivery service, it is best to fill the pool with one inch of water by hose and smooth wrinkles first. Use a water service that is able to regulate the flow of water to prevent damage. Ensure you stop at each step as noted in the instruction manual to ensure your pool is level. Bestway will not be held responsible for pools damaged or weakened by water delivery services.

4. What is the maximum fill height of the pool?

Fill pool until water capacity is 90% top rail. Never attempt to fill your pool beyond the base of the rail. We recommend leaving extra room to account for water displacement when occupants are inside the pool. You may have to top up the water during the season which has been lost through evaporation or normal use.

5. My pool is leaking, what do I do to fix it?

The pool does not need to be emptied to fix any holes. Self-adhesive underwater repair patches can be purchased at your local pool / hardware store. For external use, use the repair patch provided. For internal holes, clean the hole on the inside of the pool to wipe off any oils and algae. Cut a circle large enough to cover the hole and apply the patch securely onto the side in the water. Cut a second patch and apply to the outside of the pool for extra strength. If the hole is in the base of the pool use one patch only and weigh it down with a heavy object while it bonds. If you have patched the pool when it is empty we recommend you leave it at least 12 hours before filling.

6. Where can I buy filter cartridges and how often should I change them?

Filter cartridges to fit your filter pump should be available from the store where you purchased your pool. If not, most mass retailers sell filter cartridges as an accessory. If you are unable to obtain replacements please call our toll-free number and we will assist you in finding a source local to you. The cartridges should be changed every 2 weeks dependent upon use of the pool. Check the filter on a weekly basis and clean by hosing down any debris and particles. **Note:** Ensure your pump is disconnected from the electrical supply before checking the filter cartridge.

7. How many times a year should I change the water?

This is dependant on the amount of use the pool receives, and the attention paid to covering the pool and keeping chemicals properly balanced. If maintained correctly the water should last a full summer season. Please contact your local pool chemical supplier for detailed information regarding chemicals, they will be able to advise you how to best maintain the cleanliness of your water.

8. Do I need to take my pool down for the winter?

Yes. Above-ground pools may collapse under the weight of ice and snow and the PVC walls will be damaged. We recommend taking the pool down when temperatures fall below 8°C / 45°F. The pool should be stored indoors in a moderate temperature between 5°C / 41°F and 38°C / 100°F. Please store away from chemicals and rodents and out of the reach of children.

9. My pool is fading – why is that?

Excessive use of chemicals can cause the color of the inside of the liner to fade; this is similar to a swimsuit fading over time from repeated contact with chlorinated water.

10. How many years will the pool last?

There is no set time limit for the pool to last; following the instructions in the owner's manual and with proper care, maintenance and storage you can considerably increase the life of your pool. Improper set-up, use or care can result in failure of the pool.

11. Do you recommend the use of a filter pump with a Bestway pool?

Absolutely! We strongly recommend you use a filter pump which will maintain the cleanliness of the water.

12. Which are the most important functions of my filter pump?

The most important function of a filter pump is the elimination of every sort of impurity from the water with the aid of a filter cartridge and chemical products for its sterilization.

Limited BESTWAY® Manufacturer's Warranty

The product you have purchased comes with a limited warranty. Bestway® stands behind our quality guarantee and assures, through a replacement warranty, your product will be free from manufacturer's defects.

To enact a warranty claim, this form must be completed and submitted with a copy of your receipt/purchase to your local Bestway After Sales Center. Before any claims can be accepted, the Bestway After Sales Center may ask you to send a piece of the defective part to the centre (e.g. a cut out of the production batch number / drain valve). Please contact your local Bestway After Sales Center before sending any documents. They will provide full instructions of what is needed for your claim.

Bestway® is not responsible for economic loss due to water or chemical costs. Bestway® will not replace any products deemed to have been damaged due to negligence or having been used outside of the owner's manual guidelines.

Bestway's warranty covers manufacturing defects discovered while unpacking the product or during use, within the limits of a use and respectful of warnings and instructions given within the user's manual. This warranty applies only to product which have not been modified by any 3rd parties. The product must be stored and handled in accordance with the technical recommendations.

Please choose the type of your pool:

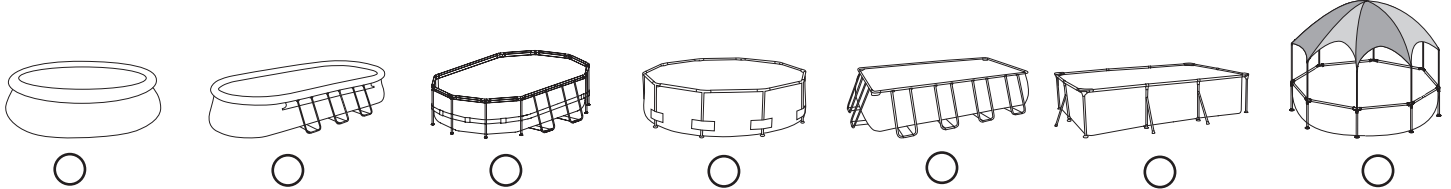

Date of purchase: _____ Customer Code Number: _____

TO: Bestway® Service Department Date: _____

FAX/E-MAIL/TEL: Please refer to your country according to the information you find on the back cover or on our website: www.bestwaycorp.com. Please provide your address details in full. **Note:** Incomplete address details will result in delayed shipments. Bestway reserves the right to charge for redelivery of undelivered packages where the recipient is at fault.

REQUIRED INFORMATION - PLEASE WRITE THE SHIPPING ADDRESS

Name: _____ Address: _____
 Zip Code: _____ Retailer: _____
 Country: _____ City: _____
 Mobile: _____ Telephone: _____
 Fax: _____ E-mail: _____

Please write the Batch Number and Item Code located near the drain valve

Batch Number: _____ Item Code: _____

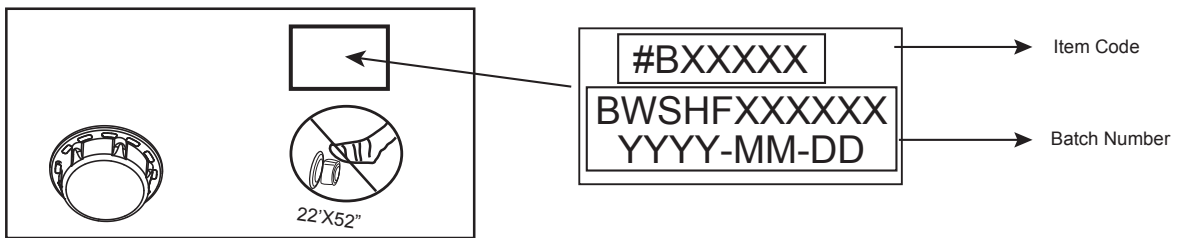

Problem description

- Item is torn / Leaking
 Faulty welding
 Faulty upper ring
 Faulty drain valve
 Other (Please describe)
 Missing part (Please use the code for the missing part. This can be found in the owner's manual.)

IMPORTANT: ONLY THE DAMAGED PART WILL BE REPLACED, NOT THE COMPLETE SET.

Bestway reserves the right to request photographic evidence of defective parts, or to require sending the item for additional testing. In order to best assist you, we request all information you provide to be complete.

FOR FAQ, MANUALS, VIDEOS OR SPARE PARTS, PLEASE VISIT OUR WEBSITE: www.bestwaycorp.com
 VIDEOS ARE ALSO AVAILABLE ON OUR BESTWAY CHANNEL ON YOU TUBE: www.youtube.com/user/BestwayService

