



Ergo 3 Lever Highback Chair INSTRUCTION MANUAL

The Maximum Weight for this product is 120kgs



This icon in assembly instructions indicates important notes that users should follow during assembly.



To reduce paper waste and protect the environment, the instruction manual uses less pages and is printed on recycled paper.

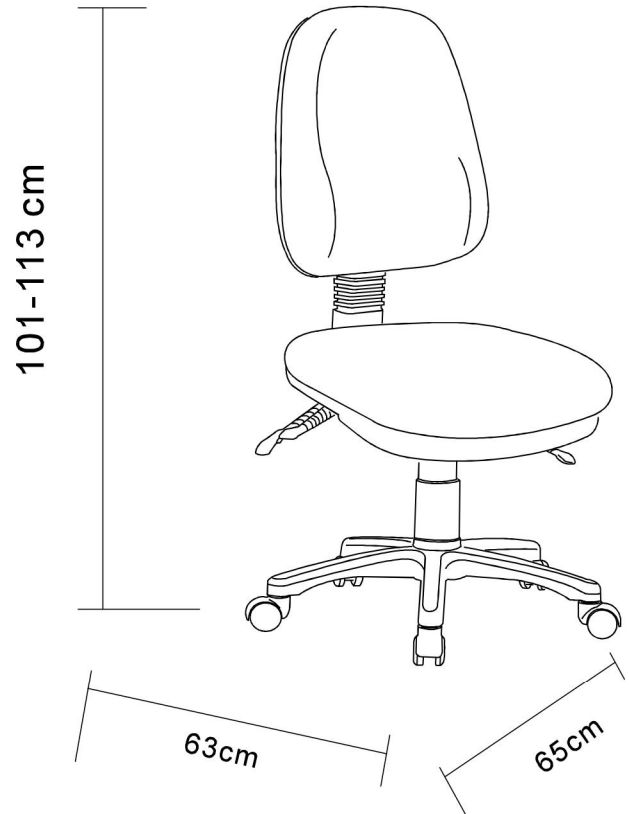

2-PERSON ASSEMBLY

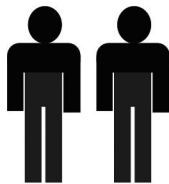

STOP
BEFORE
RETURNING
TO STORE

Read the manual.
It will help you get the best out of your product.

Still have questions?
Call After Sales Support
0800 222 246

Warranty

We pride ourselves on producing a range of quality products that are both packed with features and completely reliable. We are so confident in our products, we back them up with a two years warranty. Now you too can relax knowing that you are covered.

Customer Helpline NZ: 0800 222 246
This product is covered by two years warranty when accompanied by proof of purchase.

Marketed by The Warehouse Ltd
26 The Warehouse Way Northcote, Auckland 0627. 0800 422 274

IMPORTANT, RETAIN FOR FUTURE REFERENCE: READ CAREFULLY

Tips Before You Start

- 1 For the protection of your furniture, we recommend that the product is placed on a protected surface during assembly to prevent any damage.
- 2 Please check that all parts are present before you start the assembly of your furniture.
- 3 For ease and speed of assembly, we recommend that you identify all the parts required for each step before commencing assembly.
- 4 For larger items, please ensure that you have sufficient space and people (as indicated on page 1) to assemble your product safely.
- 5 We recommend that, where possible, all items are assembled near to the area in which they will be placed in use, to avoid moving the product unnecessarily.
- 6 During assembly please take care not to over-tighten hardware, as this may damage the product. Do not use power tools.
- 7 Always place the product on a steady and stable surface.
- 8 Do not stand on the product. Do not use the product as a stepladder.
- 9 This product is intended for indoor, household use only as it is a non-industrial product.
- 10 Please use caution and care when lifting the product to avoid personal injury and/or product damage.

Care and Maintenance

- ✓ Please periodically check all things and re-tighten as necessary.
- ✓ To clean your item, please use a damp cloth and wipe clean.
- ✓ Never allow any kind of liquid to remain on your furniture.
- ✓ Absorption can cause wood to warp or finishes to delaminate.
- ✓ Please do not place hot items (e.g., hot drinks) directly onto the surface.
- ✓ Please do not drag and pull your furniture.

Part Name

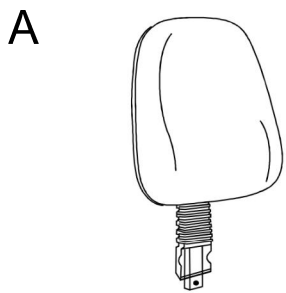
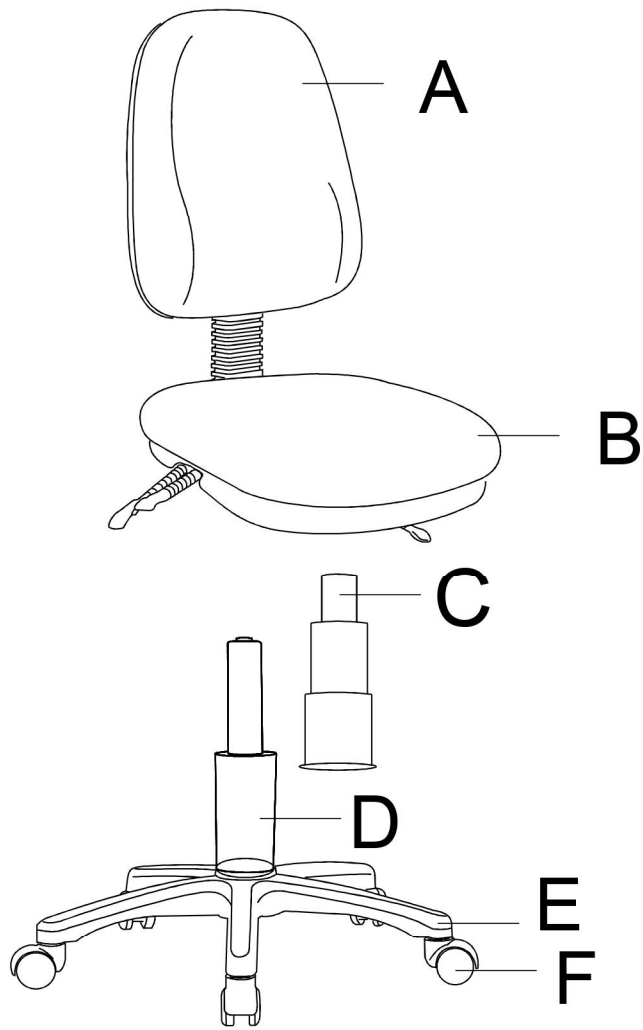

1 PC

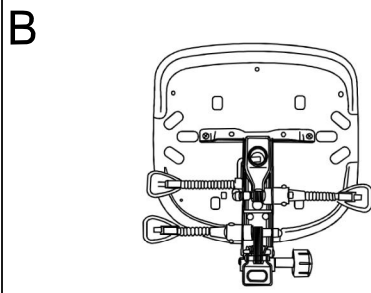

1 PC

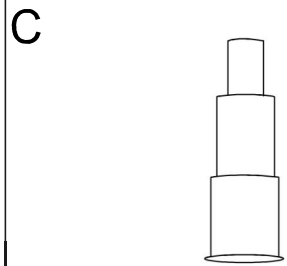

1 PC

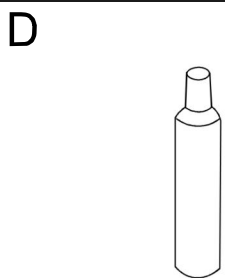

1 PC

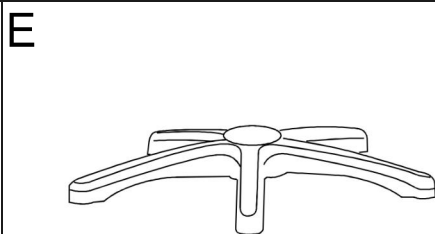

1 PC

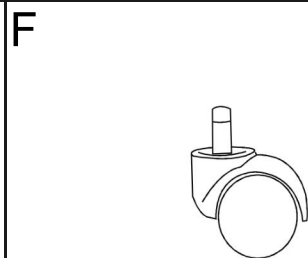

5 PCS

Assembly

Step 1

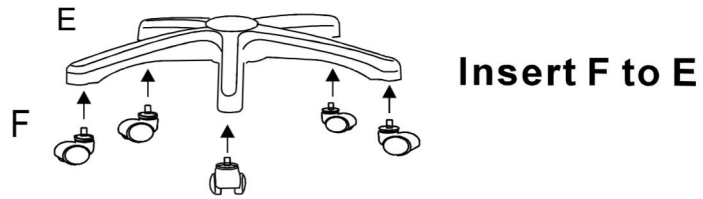

Step 2

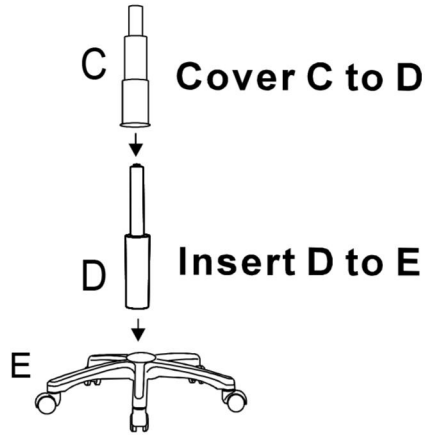

Step 3

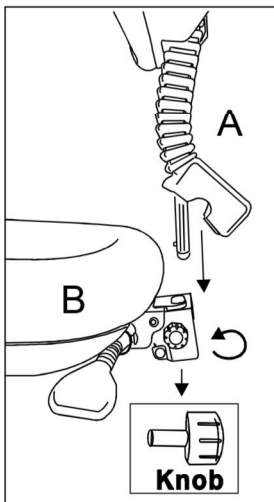

2. Insert the Tube to B

1. Turn the knob counter clockwise to loosen

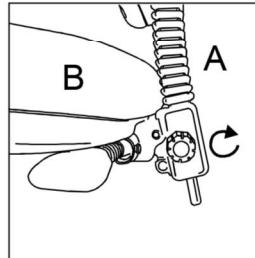

3. Fasten the Knob after Insert

Step 4

