

EPSOM
collection

E7105L – 5 DRAWER LINGERIE CHEST

Congratulations on your purchase of your **EPSOM 5 DRAWER LINGERIE CHEST**. The **EPSOM** Collection is made in New Zealand from 100% New Zealand made MDF –an environmentally sound renewable resource.

If you require any parts or assembly advice or have any questions please go to www.warehousefurniture.co.nz or call us on **0800 100 858**.

WHERE TO ASSEMBLE YOUR LINGERIE CHEST

Assemble your unit on a clean and smooth surface, free of anything which may damage the laminated surface. A carpeted floor is ideal. If assembling on a workbench or table we suggest you cover it with the carton the unit was packaged in.

Warning! Never leave hardware parts where children can reach them. Small parts may be a choking hazard!

PARTS LIST







Please check you have all the parts before beginning to assembling your cabinet. The measurements will help you identify each part. If any parts are missing or damaged please contact us directly for replacements and advice. Do not call the store you bought the cabinet from as they will be unable to help you. **Note: You will find two pieces of board fitted across the ends of the package. These are for packing purposes only and are not part of the cabinet.**

QTY	PART	MEASUREMENTS	NOTES
1	Top	465 x 396 x 25mm	25mm thick. Blue mark on back edge.
1	LH End	1017 x 372 x 15mm	Finished on both sides. Green mark on back
1	RH End	1017 x 372 x 15mm	Finished on both sides. Red mark on back edge.
1	Top Drw Front	413 x 141 x 15mm	Black finish on one side
4	Bottom Drw Fronts	413 x 195 x 15mm	Black finish on one side
2	Back Rails	419 x 80 x 15mm	Plain
1	Front Toeboard	419 x 80 x 15mm	Black finish on one side
1	LH Drw Side – Sml	340 x 115 x 12mm	Plain
4	LH Drw Side - Lrg	340 x 160 x 12mm	Plain
1	RH Drw Side – Sml	340 x 115 x 12mm	Plain
4	RH Drw Side - Lrg	340 x 160 x 12mm	Plain

Job No

1	Drawer Back – Sml	369 x 110 x 12mm	Plain
4	Drawer Back – Lrg	369 x 155 x 12mm	Plain
5	Drawer Bottoms	379 x 339 x 4mm	Plain 4mm
1	Back Panel	962 x 439 x 4mm	Plain 4mm

HARDWARE LIST

QTY	PART	CODE	
20	Connecting Bolts	H1	
10	15mm Metal Cams.	H2	
10	12mm Metal Cams.	H3	
20	Drawer Slide Screws	H4	
20	Small Screws	H6	
20	Woodscrews	H9	
20	Large Dowels	H15	
1	Bag of small Nails	H27	
5	Bow Handles		
5	Metal Drawer Slide sets		
4	Nail on Glides	H37	

COLOUR CODING

To help identify the parts, the main components are colour coded with a pen mark on the back edge of the panel. (The edge without any laminate on it.)

- **RED** **Right Hand Parts.** (E.g. RH End, RH Division, RH Drawer Side.)
- **GREEN** **Left Hand Parts.** (E.g. LH End, LH Division, LH Drawer Side.)
- **BLUE** **Tops**
- **PURPLE** **Bases**

5 YEAR WARRANTY.

This furniture carries a **5 year warranty** against defective material or workmanship, excluding misuse and normal wear and tear. Obviously, as this unit is customer-assembled we cannot guarantee cabinet failure or damage from incorrect assembly. **All claims need proof of purchase – to ensure this register @ www.warehousefurniture.co.nz.**

Follow the assembly instructions carefully and take note of the precautions below.

- **Avoid direct sunlight wherever possible.**
- **Keep cabinet in a dry place.**
- **Wipe off spilt liquids immediately.**
- **Avoid placing hot items directly on the surface.**
- **Clean with a soft cloth and a mild polish.**
- **Do not allow nail polish, removers, deodorant etc. to come into contact with the surface.**

CAM INSTALLATION & OPERATION

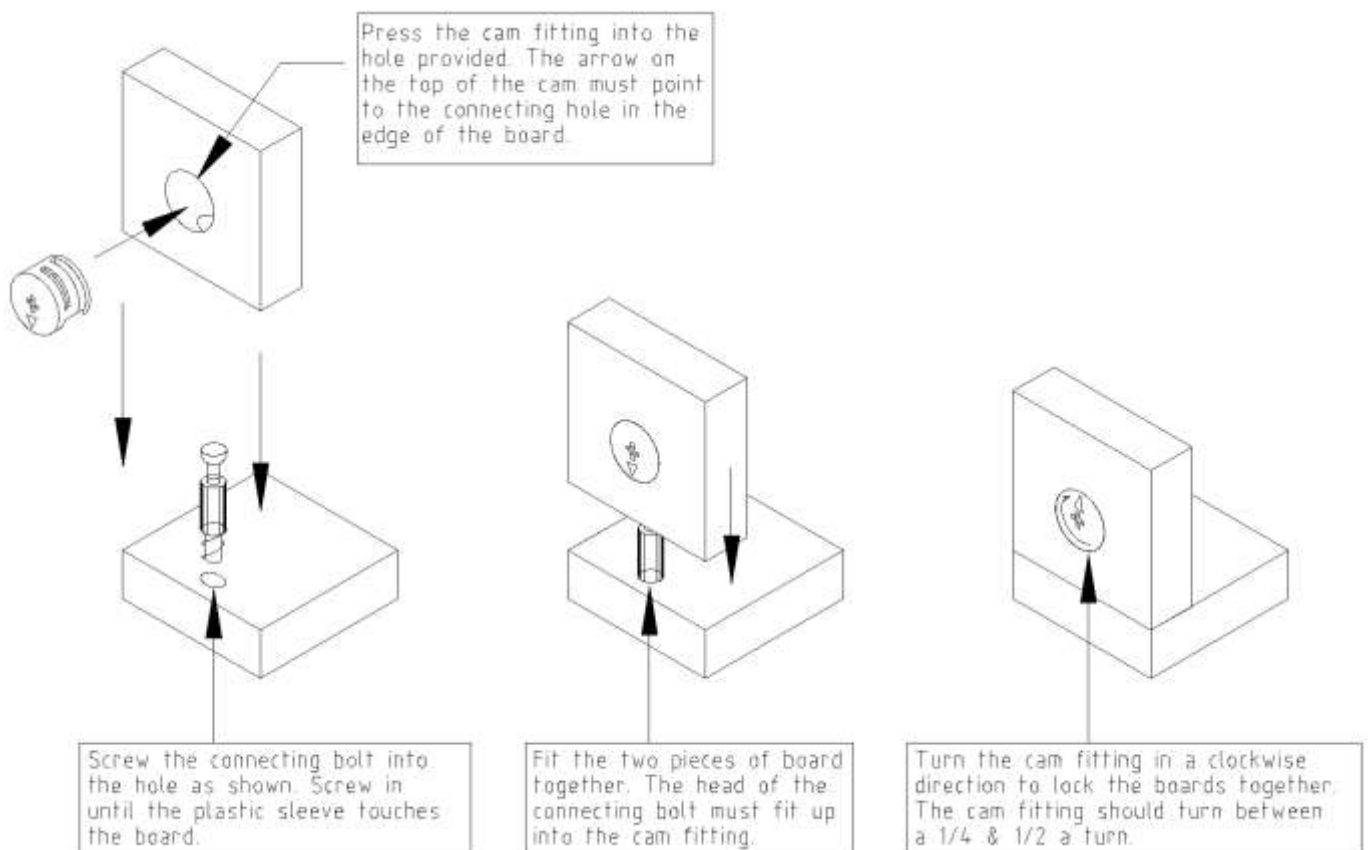

For assembly advice or parts go to www.warehousefurniture.co.nz or call 0800 100 858

DRAWER SLIDES

Your pack will contain five sets of Metal Drawer Slides. These are bundled together with adhesive tape. Each set comprises of 4 components. Undo the tape on one set at a time and separate the parts into four piles.



LEFT HAND PART (DL)



RIGHT HAND PART (DR)

The Drawer Slide components shown above are attached to the **drawers**. They have the letters **DR** or **DL** stamped on them to indicate left hand or right hand components. Put these parts aside for attaching to the drawers later on.

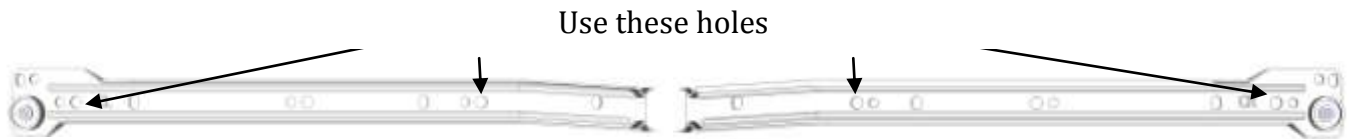

LEFT HAND PART (CL)

RIGHT HAND PART (CR)

The Drawer Slide components shown above are to be attached to the **cabinet**. They have letters **CR** or **CL** stamped on them to indicate left hand or right hand components.

INSTALL THE HARDWARE

STEP 1

Lay the LH End with holes facing upwards on a smooth clean surface. Take five LH cabinet drawer slides (CL) and screw them to the LH End using the **H4 Drawer Slide Screws**. Use the holes as indicated in the diagram above.



H4

Insert two **H2 Cams** as shown in diagram. Make sure the arrow on the top of the Cam points towards the top edge of the End.



H2

Push two **H15 Dowels** into the top edge of the End as shown.



H15

Screw three **H1 Connecting Bolts** into the holes indicated on the opposite diagram.



H1

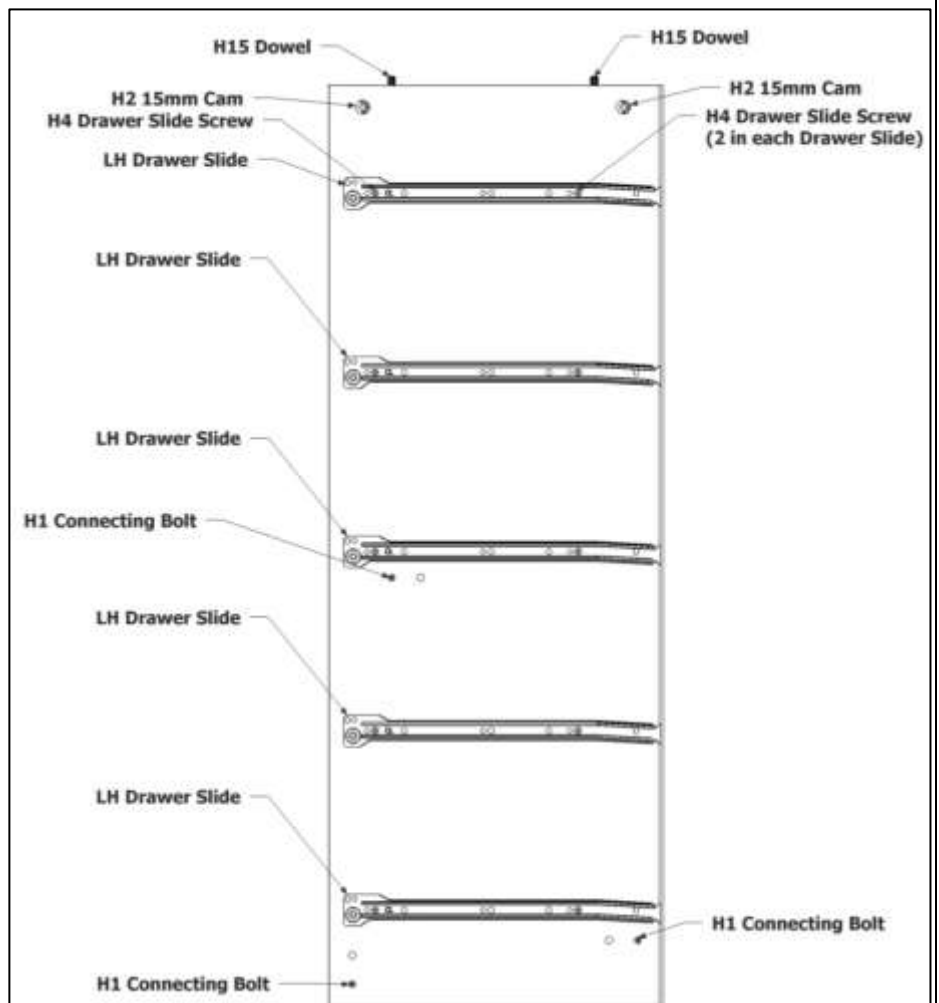

STEP 2 - this step is the same as the previous but it is the Right Hand End

Lay the RH End on a smooth clean surface.

Take five RH cabinet drawer slides (CR) and screw them to the RH End using the H4 Drawer Slide Screws.

H4



Insert two **H2 Cams** as shown in diagram. Make sure the arrow on the top of the Cam points towards the top edge of the End.

H2



Push two **H15 Dowels** into the top edge of the End.

H15



Screw three **H1 Connecting Bolts** into the holes indicated on the opposite diagram.

H1

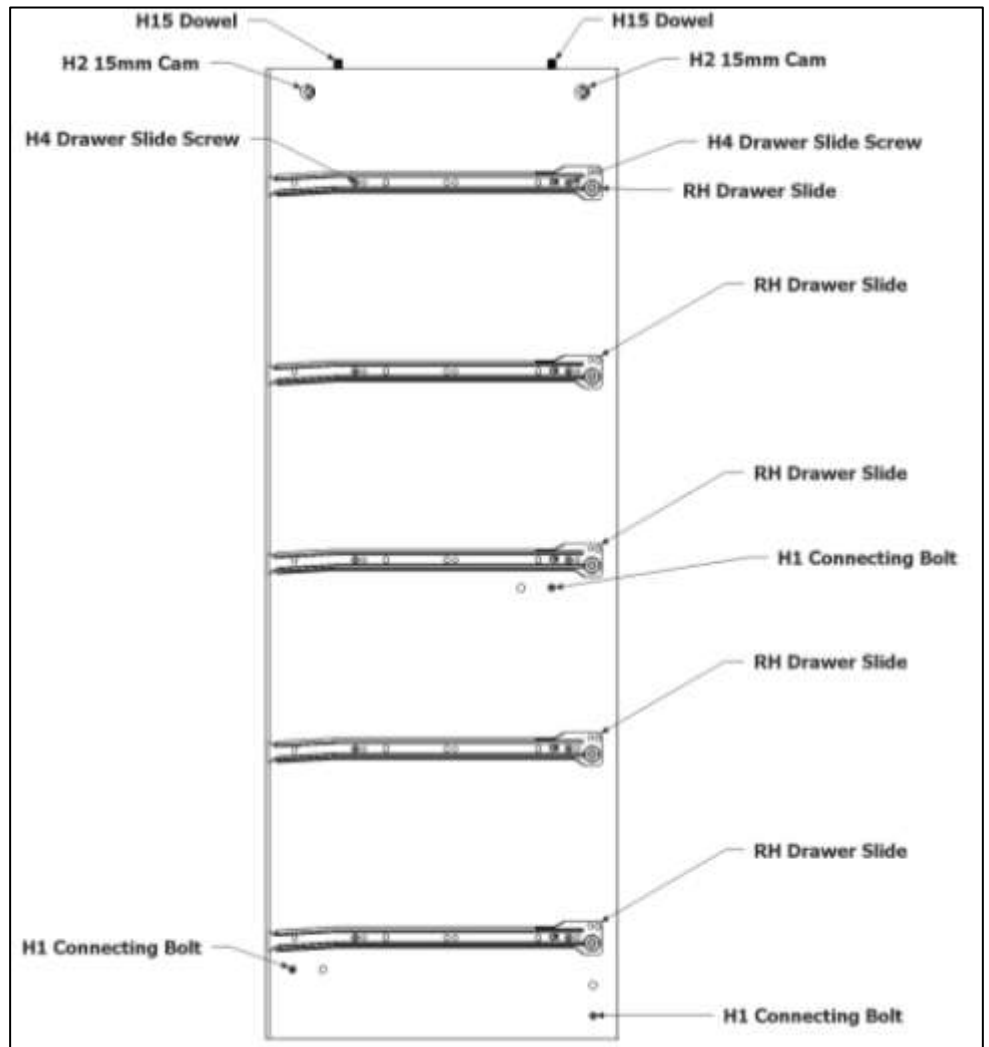

STEP 3

Lay the Top laminate side down on a clean, clear surface.

Screw the **H1 Connecting Bolts** in the holes as indicated in the drawing below.

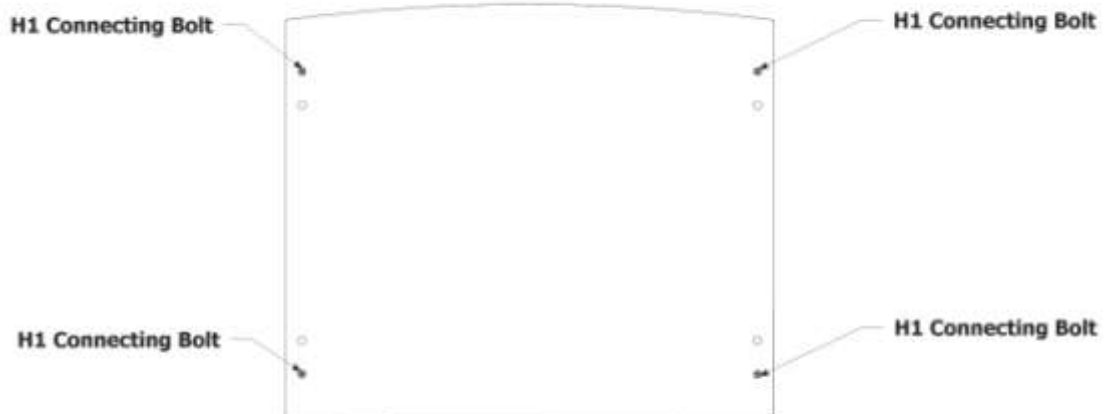

STEP 4

Your pack will contain three boards the same size.

- 1 x Back Rail (no finish)
- 1 x Rear Toeboard (no finish)
- 1 x Front Toeboard (black finish on one face)

Install two **H2 Cams** into each piece as indicated



Push the **H15 Dowels** into each end of the boards as indicated.



ASSEMBLE THE CHEST

STEP 1 - Attach the Rail and Toeboards to the LH End.

Position the Rails and Toeboards over the Connecting Bolts installed in the End - take note of the drawing below. Ensure the laminate side of the Front Toeboard face outwards.

The Back Rail and the Rear Toeboard are interchangeable - Make sure the Cams face towards the top of the End.

Lock Rails and Toeboards in place by tightening all three Metal Cams in a clockwise direction at least a ¼ of a turn.

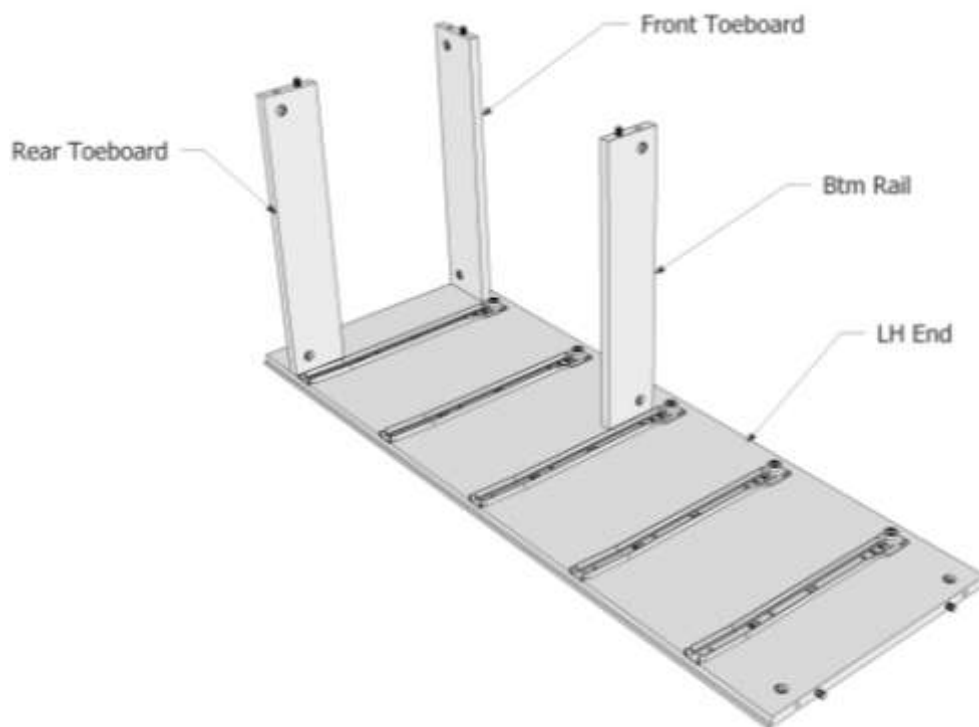

STEP 2 - Attach the RH End

Turn the LH End with the Rail and Toeboards attached onto its back edge.

Fit the RH End to the Rails and Toeboards by fitting the Connecting Bolts in the RH End into the Cams in the Rails and Toeboards as shown in the drawing below.

Lock the RH End to the Rails and Toeboards by tightening **all** the Cams in a clockwise direction.

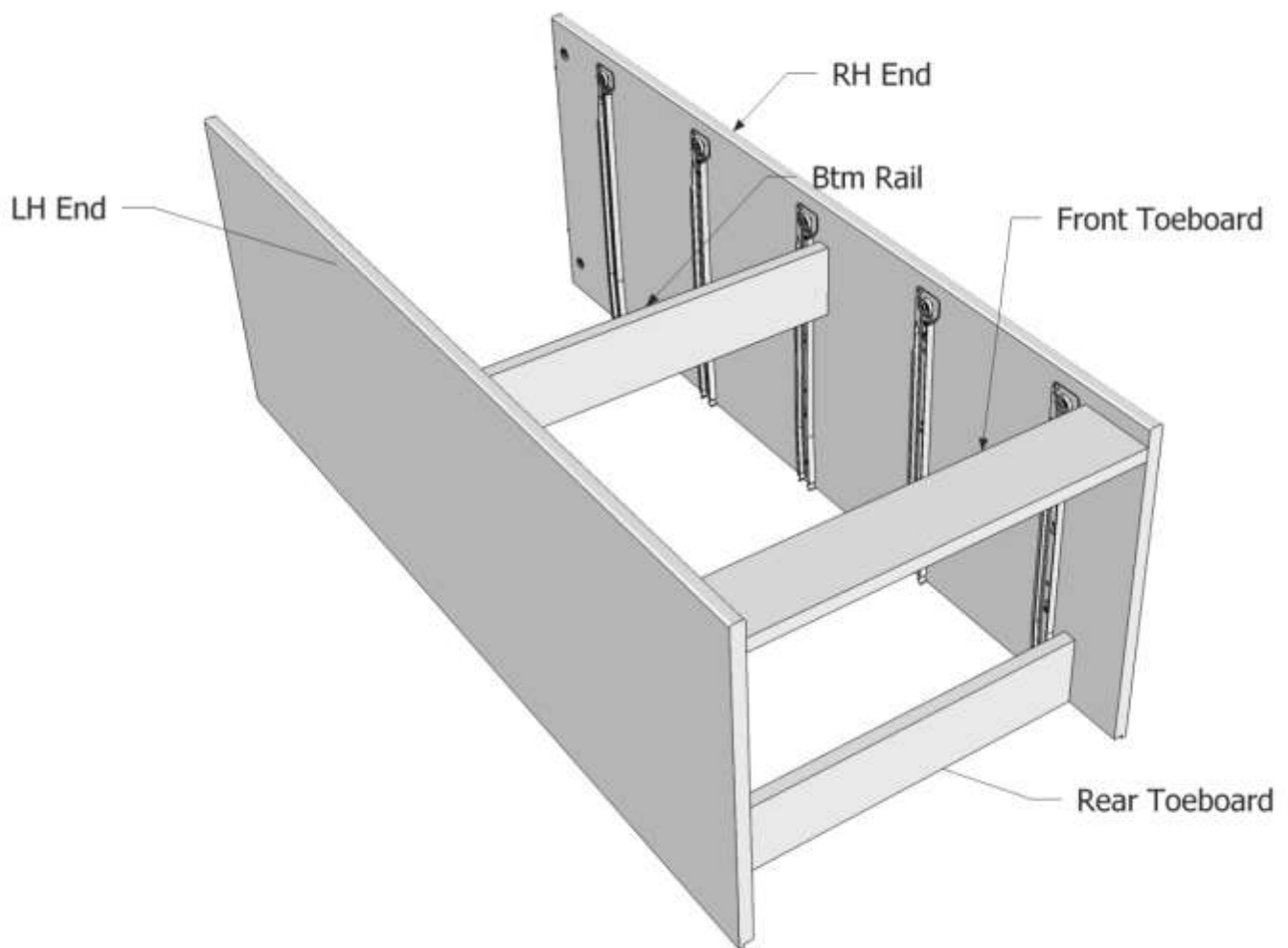

STEP 3

Turn the Top onto its back edge and slide it onto the top of the Ends as shown below. Fit the Connecting Bolts down into the Cams in the Ends.

Turn all four Cams in a clockwise direction to lock the Top to the Ends.

Tap the four **H37 Nail on Glides** into the end of the Ends. Space them about 20mm in from the edge.

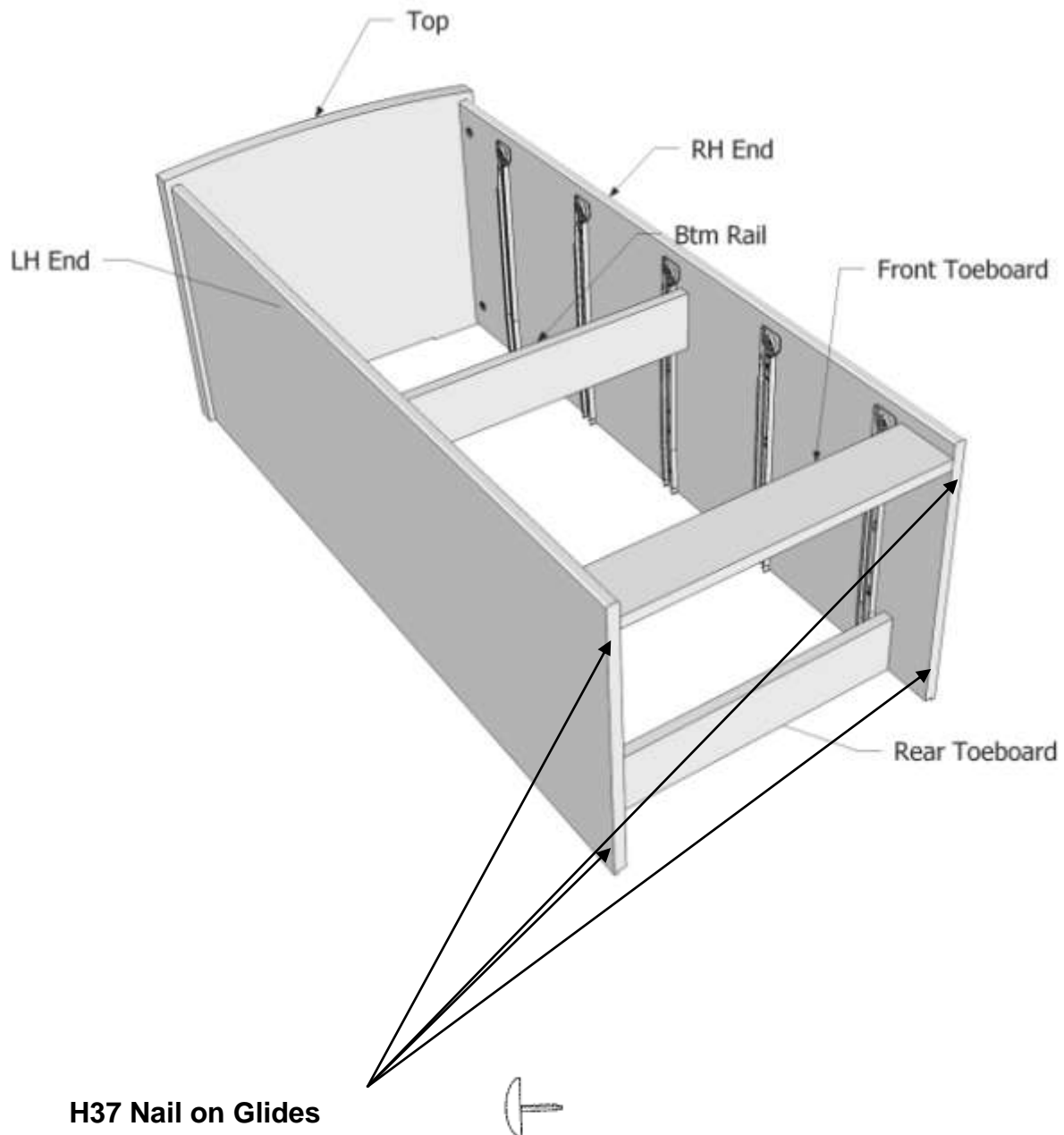

STEP 4 - Attach the Back Panel

Carefully turn the Chest onto its front edge. Make sure the surface is clear.

Fit the Back Panel into place and tack in place with the nails provided. Make sure the Ends are straight. Space the nails about 100mm apart.

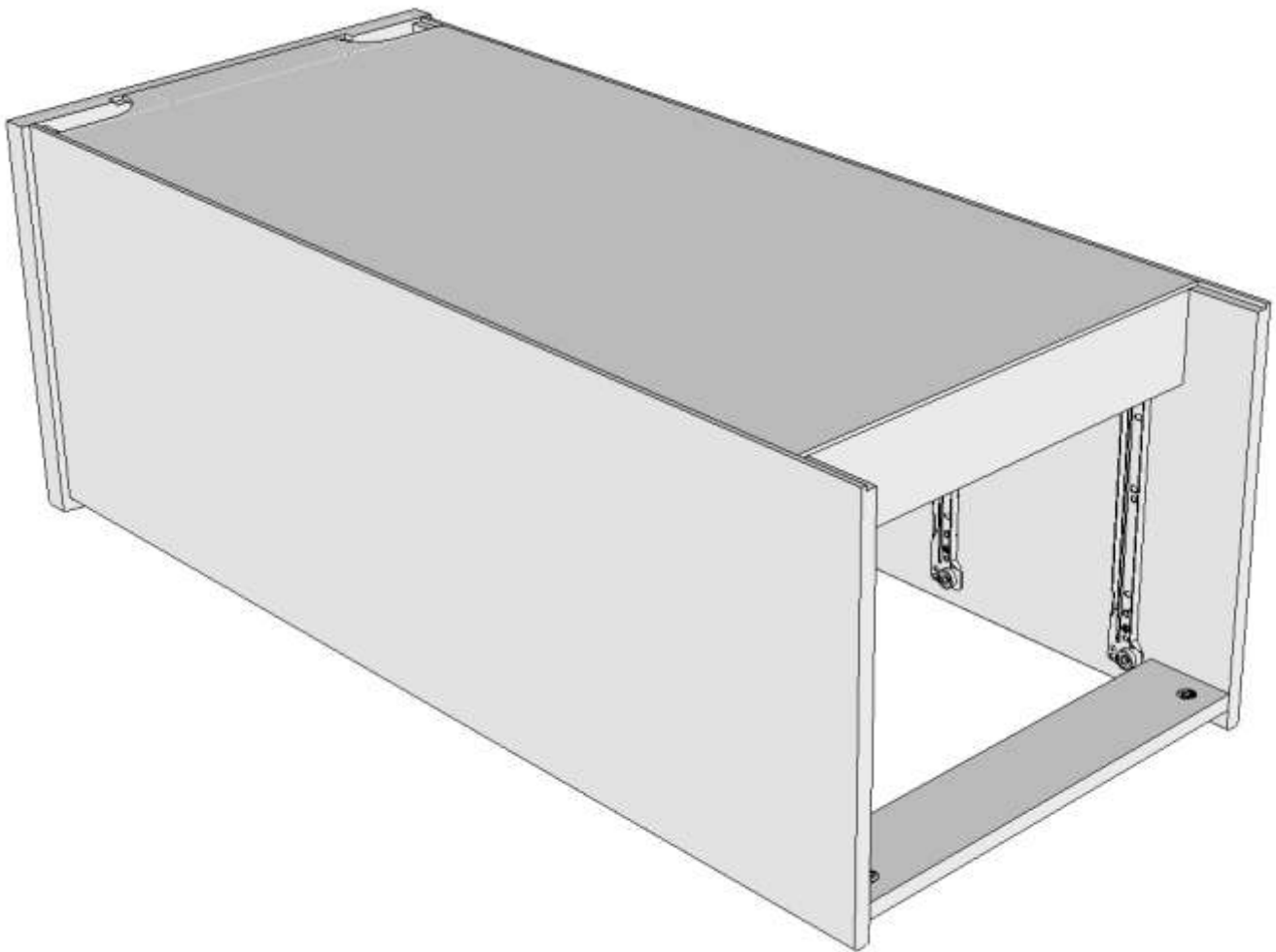

ASSEMBLE THE DRAWERS

Your **Epsom Lingerie Chest** will have one shallow top drawer and four deeper bottom drawers. All Drawers are constructed in the same manner and consist of the same parts.

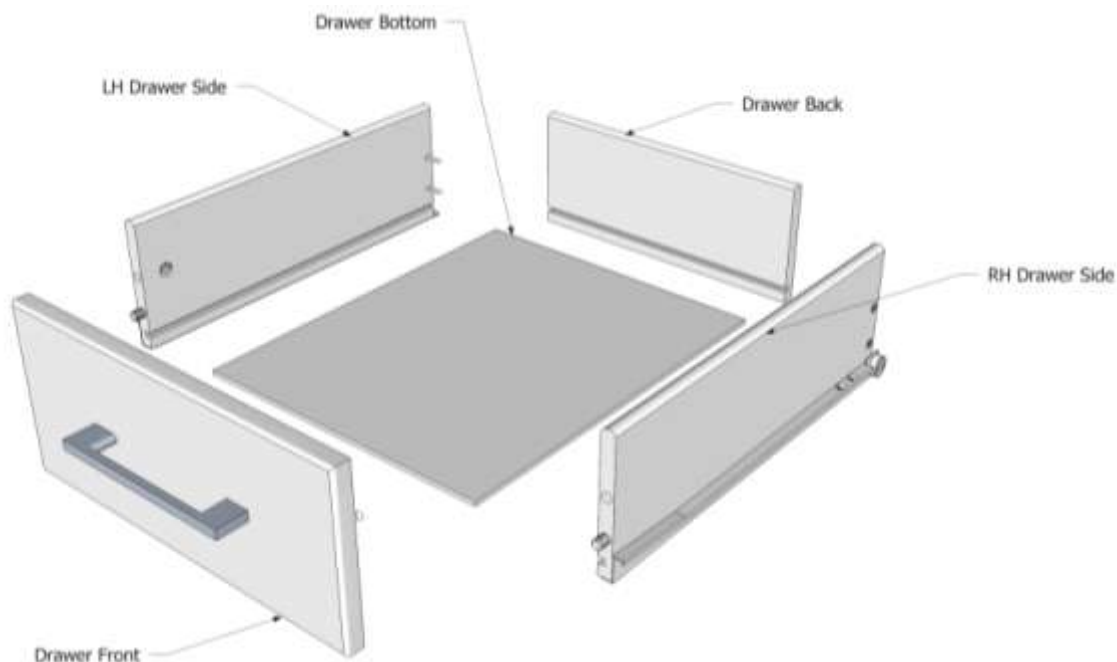

STEP 1

Install the hardware as shown below.

Note: Be sure that the arrow on the Metal Cam points to the end of the drawer side nearest it.

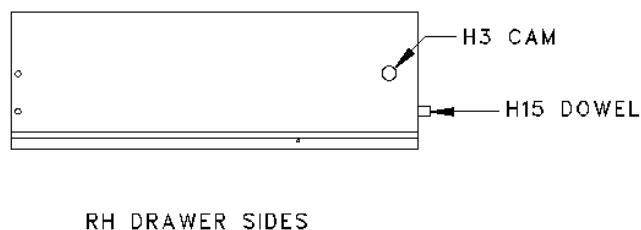
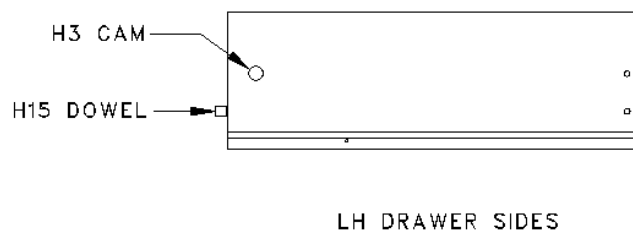
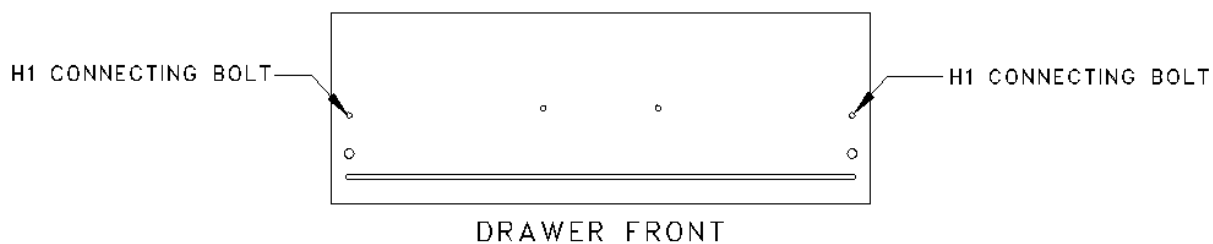

H15 Dowel



H3 Cam



H1 Connecting Bolt

STEP 2

Lay the Drawer Front face down on a smooth, clean surface.

Attach the LH and RH Drawer Sides by fitting them down into place over the Connecting Bolts installed in the Drawer Front. Turn the Metal Cams clockwise to lock the Drawer Sides in place.

Next slide the Drawer Bottom into place in the grooves in the Drawer Sides and Drawer Front. Fit the Drawer Back into place between the Drawer Sides and secure with four **H9 Woodscrews** as shown below.

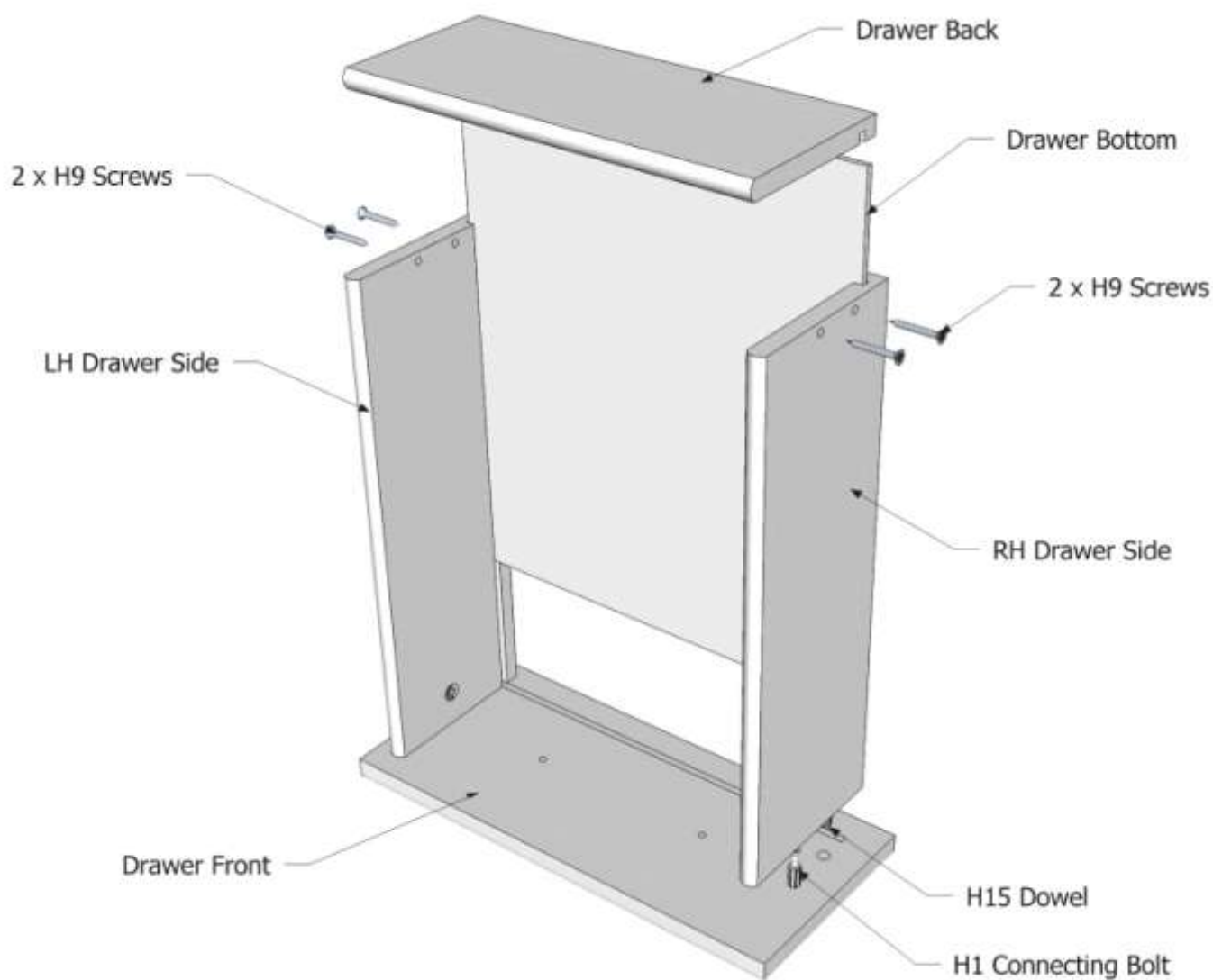
**H9 Woodscrew**

STEP 3

Turn the drawer upside-down as shown and attach the Drawer Slides (*DR* and *DL*) with the four **H6 Small Screws** as shown below. Each slide requires two screws.

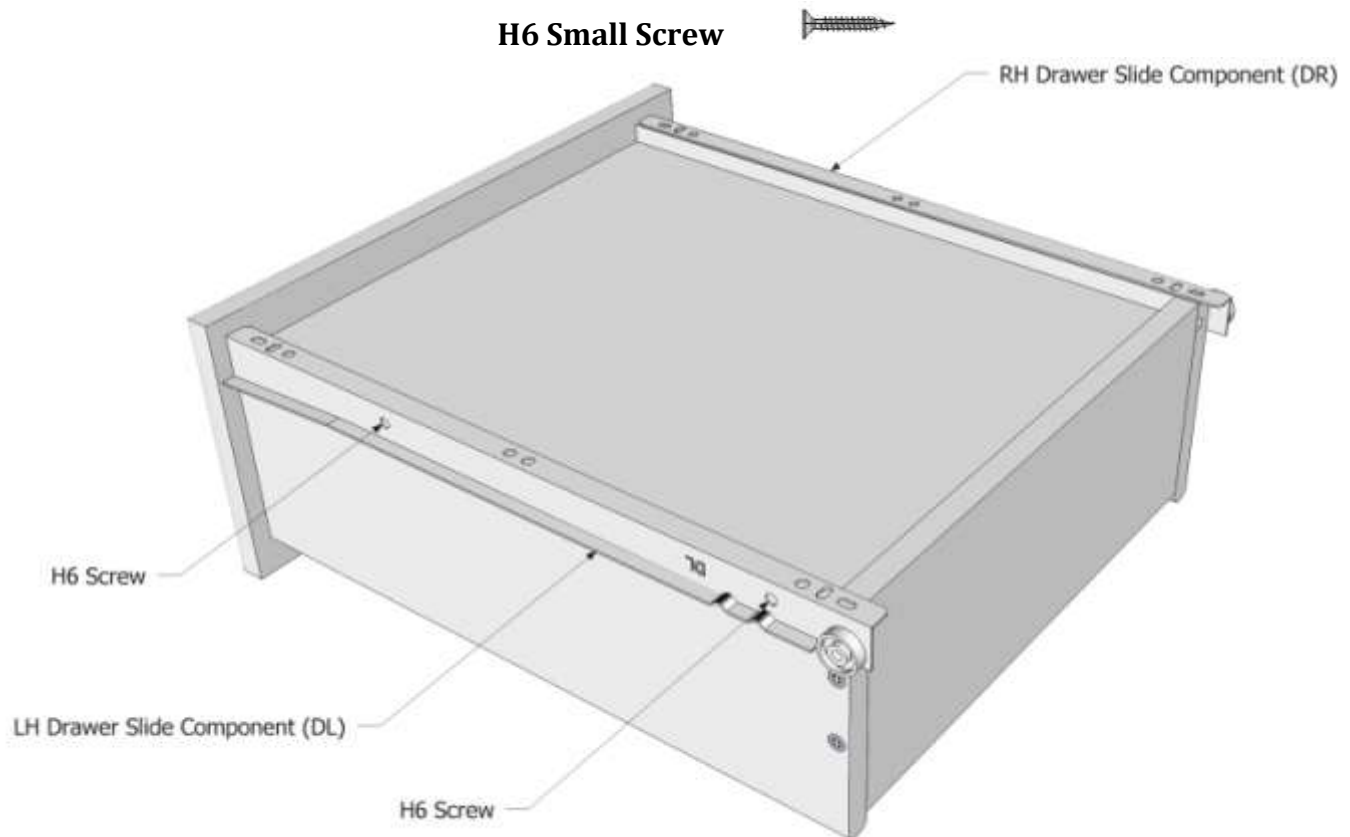
**STEP 4**

Attach the Drawer Handles to the Drawer Front using the screws provided.

Fit the drawers into the cabinet. Make sure that the rollers at the back of the drawer go behind the front rollers in the cabinet and into the channel of the drawer slide. It helps to lift the front of the drawer up a little when doing this.



CONGRATULATIONS, YOUR *EPSOM 5 DRAWER LINGERIE CHEST* IS NOW COMPLETE.

THANK-YOU FOR SUPPORTING NEW ZEALAND MADE FURNITURE