

**citrus**  
hi-lo chair

instruction  
MANUAL



follow us on    
[motherschoice.com.au](http://motherschoice.com.au)

*the only choice*

# contents

<i>assembling the highchair</i>	<i>pg.</i>
Components list .....	4
Opening highchair .....	5
Height adjust .....	6
Back rest adjust .....	7
Meal tray .....	8-9
 <i>using the highchair</i>	
Folding highchair .....	10
Restraint system .....	11
Rear wheels .....	12
 <i>care and maintenance</i>	
Care and maintenance .....	12
Notes .....	13
Product registration .....	15
 <i>contacts</i>	
Customer service .....	16

These instructions detail the safe use, assembly and maintenance of your product. Please read these instructions carefully and ensure that they are followed at all times. Failure to do so could result in serious injury or death.



## **WARNING TO AVOID INJURY OR DEATH:**

- **FOLLOW THE MANUFACTURER'S INSTRUCTIONS.**
- **DO NOT LEAVE CHILDREN UNATTENDED.**
- **THE HARNESS MUST ALWAYS BE USED AND CORRECTLY FITTED. MOST INJURIES FROM HIGHCHAIRS ARE CAUSED BY FALLS.**
- **POSITION THE HIGHCHAIR AWAY FROM SOLID STRUCTURES AND BENCHES TO AVOID INJURIES CAUSED BY FALLS AND BY ACCESS TO DANGEROUS ITEMS.**
- The weight of the child using the highchair should not exceed 15kg.
- The child should be secured in the highchair at all times by the restraining system. It is recommended that the highchair be used in the upright position only by children capable of sitting upright unassisted.
- Check that the highchair is fully erected and ensure that all locks are engaged before placing a child in it.
- Ensure that the highchair is placed on a flat, even, horizontal and stable surface.
- Never use the highchair with the seat pad removed.
- Do not elevate the highchair on any structure or table.
- To reduce the risk of injury, position the highchair away from furniture, walls, hot surfaces, hot liquids, window coverings, window cords and electrical cords. Position the highchair away from furniture when the chair is not being used at a table with the tray removed.
- Do not raise, lower, fold or move the highchair when a child is in it.
- Make sure children and their fingers are clear of any moving parts.
- Do not allow children to stand on the seat, as the highchair may become unstable.
- To avoid danger of suffocation, keep any plastic bags away from babies and children.
- Regularly inspect the highchair for any part that is loose, broken, torn or missing. Attend to the problem as soon as it is noticed.
- Do not use the highchair if it is not working correctly and immediately seek repair.
- Use only those accessories which are supplied by Dorel Australia and approved for use with this highchair.
- This product is not intended for commercial use.

# **citrus**

## **hi-lo chair**

### *components list*



- A** Back rest
- B** Seat insert
- C** Fold button  
(left and right)
- D** Height adjusters  
(left and right)
- E** Tray storage

- F** Foot rest
- G** Crotch restraint
- H** Meal tray
- I** Safety harness
- J** Seat back recline lever  
(not shown)

# **citrus** hi-lo chair *assembly*

1a

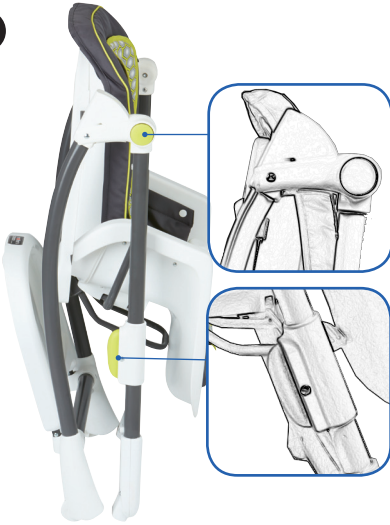

## Step 1: open the highchair

- Place the highchair with its feet secure on the floor.
- Depress the buttons located in the centre of each hinge together (Figure 1a).
- Extend the legs outward (Figure 1b).
- Continue this action until the leg assembly is securely locked in position on both sides (Figure 1c).
- Ensure that the frame assembly locks have fully engaged.

### *mother's choice tip...*

If the highchair has a security tie, please remove it.

1b



1c



# citrus

## hi-lo chair

### assembly

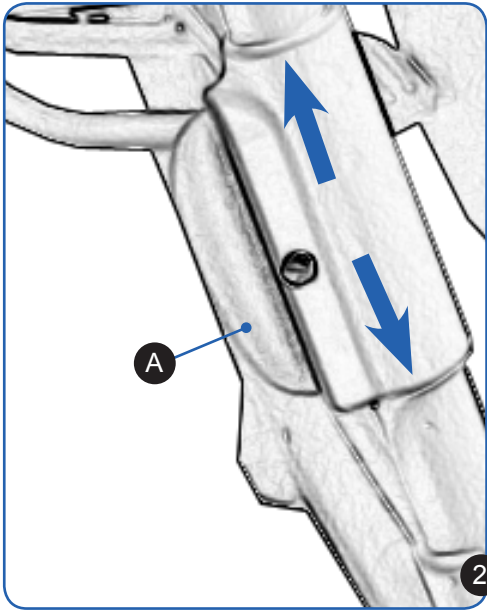

### step 2: adjust seat height

- To adjust the seat height, squeeze and hold the buttons (A) on each side of the legs and slide the seat up or down (Figure 2).
- Once adjusted, release the buttons and allow the seat to lock into position.

#### *mother's choice tip...*

It may be easier to adjust the seat height by placing your foot on the front leg cross tube to steady the highchair while adjusting.

# **citrus**

## **hi-lo chair**

### *assembly*

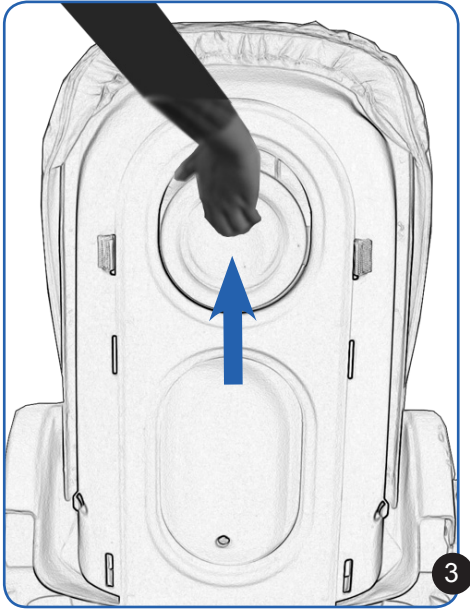

### *step 3: adjust back rest*

- Adjust the position of the back rest by lifting the adjustment lever at the rear of the seat upwards (Figure 3).
- Position the back rest in the required position and release the adjustment lever to allow the seat to lock into position.



## **WARNING**

The highchair should be used in the upright position only by children capable of sitting upright unassisted.

# **citrus**

## **hi-lo chair**

### *meal tray*

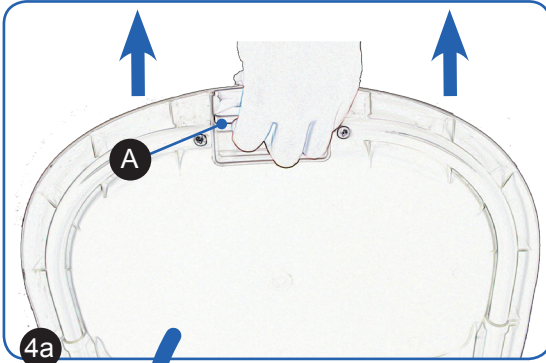

### *step 4: attach the tray*

- Align the tracks on the underside of the tray with the tray supports on either side of the seat.
- Insert the tray into the supports until it locks into position.

### *removing the tray*

- Squeeze the release lever (A) located on the underside of the tray, and remove (Figure 4a).
- Insert the tray into the holes on the rear legs to store (Figure 4b).

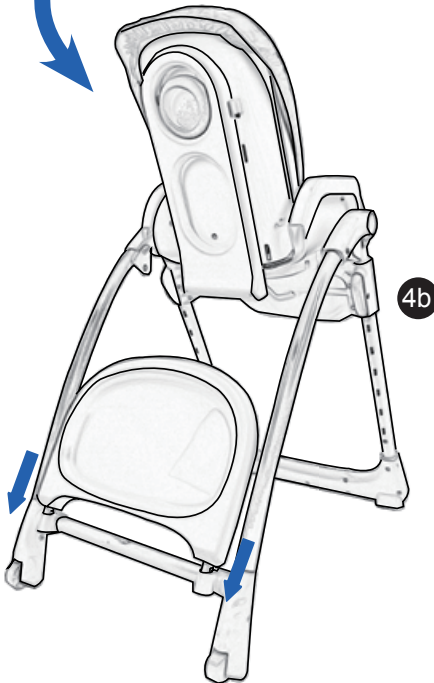



**citrus**  
**hi-lo chair**  
*meal tray*

*step 5: adjusting the tray*

- The tray can be adjusted to different positions.
- The release lever is located on the underside of the tray.
- Squeeze the release lever and move the tray to the desired position.
- Once adjusted, release the lever. Ensure that the tray has locked into position.

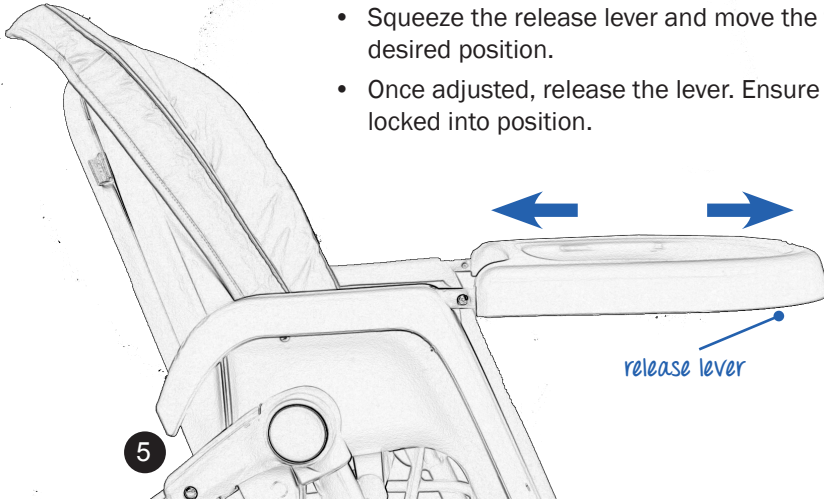

# citrus

## hi-lo chair

### folding highchair

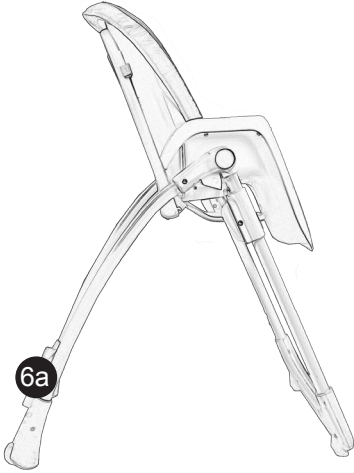

#### to fold the highchair

- Before folding: remove the tray, adjust the seat to the upright position and lower the seat fully (Figure 6a).
- Press the buttons located on the centre of each hinge together, to allow the hinges to fold, (Figure 6b).
- Assist the front and rear legs to come together.
- Ensure that the frame has closed and the locks have fully engaged and secured on both hinges (Figure 6c).
- Store in a safe location.

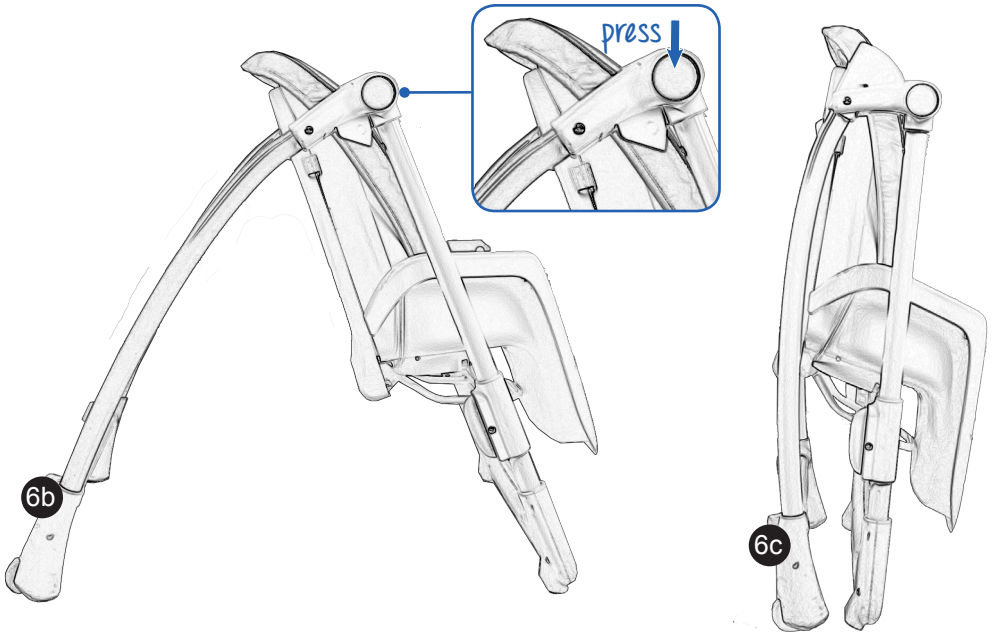

# citrus

## hi-lo chair

### restraint system

#### to use the restraint system

- Place child in the seat with the crotch strap between the child's legs and fasten both buckles and shoulders (Figure 7).
- The harness straps can be adjusted by moving each strap slider.
- The buckle is release by squeezing the buckle tongues together.

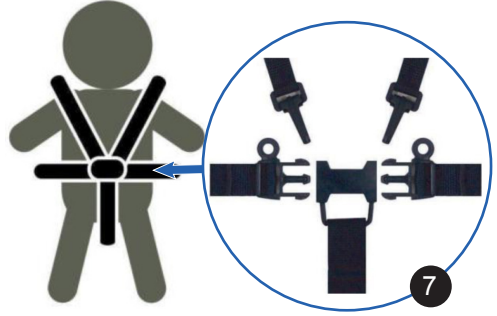

#### to adjust the shoulder strap

- Fold the T-shaped strap ends and then push through the desired slots (Figure 8).



### **WARNING**

Prevents serious injury or death from infant falling or sliding out. ALWAYS use the restraint system provided.

# **citrus**

## **hi-lo chair**

### *rear wheels*

#### *to use the rear wheels*

- Remove the child from the highchair, slightly lift the front legs from the floor.
  - The highchair can now be manoeuvred on the rear wheels.
- 

### *care and maintenance*

#### *highchair and trays*

- Wipe with soft, damp cloth and warm, soapy water and allow to dry

#### *insert trays (if supplied)*

- Dishwasher safe - top rack only

#### *seat pad*

- Wipe with soft, damp cloth and warm, soapy water and allow to dry
- DO NOT BLEACH
- Do not place in dryer

#### *harness*

- Harness and crotch straps should be surface washed and air dried only
- Do not place in washing machine or dryer





## mother's choice tip...

Visit us online to register your new Mother's Choice product.



follow us on    
[motherschoice.com.au](http://motherschoice.com.au)

[www.dorel.com.au/product-registration](http://www.dorel.com.au/product-registration)

## benefits of registration

- Your safety - allows us to contact you with important product notifications.
- Confirmation of ownership - provides a record in case of product loss or theft.
- Improved product development - helps us continue to design products that meet your needs.

*to prevent loss or fading,  
please attach your receipt here:*

motherschoice.com.au

DOREL AUSTRALIA PTY LTD  
655-685 Somerville Road  
Sunshine West Victoria 3020  
Email: customerservice@dorel.com.au  
Phone: 1300 809 526  
Hours: 8:30 am - 5:00 pm Monday to Friday

IGC DOREL NEW ZEALAND LTD  
14 Sir William Avenue  
East Tamaki Auckland 2013  
Email: customerservice@igc.co.nz  
Phone: 0800 628 000 (toll free)  
Hours: 8:00 am - 5:00 pm Monday to Friday

015019 - Citrus Hi-Lo Chair - 03 - 14



Specifications are subject to change without notice.  
Copy or reproduction without permission is prohibited.  
© 2013 Dorel Australia Pty Ltd. All Rights Reserved.

[www.dorel.com.au](http://www.dorel.com.au)