

AKAI

Makes Sense



Stainless Steel Dishwasher

INSTRUCTION MANUAL

MODEL: AK-14PLSS



Contents

- 03 General Safety Instructions**
- 06 Product Overview**
- 09 Installation**
- 13 Getting Started**
- 14 Features**
- 16 Instructions**
- 26 FAQs and Troubleshooting Guide**
- 30 Other Useful Information**

General Safety Instructions

IMPORTANT SAFETY INSTRUCTIONS READ CAREFULLY AND KEEP FOR FUTURE REFERENCE

Read this manual thoroughly before first use, even if you are familiar with this type of product. The safety precautions enclosed herein reduce the risk of fire, electric shock and injury when correctly adhered to. Keep the manual in a safe place for future reference, along with the completed warranty card and purchase receipt. If applicable, pass these instructions on to the next owner of the appliance.

Always follow basic safety precautions and accident prevention measures when using an electrical appliance, including the following:

Pay particular attention to safety messages that follow the words:

DANGER, WARNING and CAUTION.

These words are used to alert you to a potential hazard that can seriously injure you and others. The instructions will tell you how to reduce the chance of injury and let you know what can happen if the instructions are not followed.

DANGER means that failure to read this safety statement may result in severe personal injury.

WARNING means that failure to read this safety statement may result in extensive product damage or serious personal injury.

CAUTION means that failure to read this safety statement may result in minor or moderate personal injury, property or equipment damage.

Electrical safety and cord handling

- **Voltage:** Before connecting and turning on the appliance, ensure the electrical voltage and circuit frequency correspond to those indicated on the appliance rating label.
- **WARNING!** Ensure the outlet is properly earthed to the ground. If unsure, consult a qualified electrician or a service representative. Improper connection of the equipment grounding conductor can result in the risk of an electric shock if the appliance malfunctions.
- **WARNING!** Do not modify the cord and plug provided with the appliance; if it does not fit the outlet, have a proper outlet installed by a qualified electrician.
- **WARNING!** If the supply cord is damaged, do not use the appliance. A damaged cord must be replaced by the manufacturer or its service agent or a similarly qualified person in order to avoid a hazard. Contact our after sales support centre.
- **Connection:** Do not use an adaptor; do not use an extension cord. We recommend you connect the appliance to a separate circuit serving only this appliance.
- **Power cord:** Do not kink or damage the power cord. Position it out of the way so no one steps on or places anything on the cord or against it.

General Safety Instructions (Cont.)

- **Inserting/removing the plug:** Before you insert or remove the plug, make sure the appliance is switched off and the power is switched off at the electrical outlet. Remove by grasping the plug, do not pull on the cord.
- **CAUTION!** To reduce the risk of electric shock, do not immerse the unit, cord or plug in water or other liquid. Do not expose it to rain or moisture.
- **Auto switch off:** To save energy, in standby mode the appliance will switch off automatically when there is no operation in 30 minutes.
- **RCD:** Unless your home is already fitted with a residual current device (safety switch), we recommend installing an RCD with a rated residual operating current not exceeding 30mA to provide additional safety protection when using electrical appliances. See your electrician for professional advice.

Installation

- **WARNING!** Do not install the dishwasher yourself. Have it installed by an appropriately qualified, licensed plumber or dishwasher installer only.
- **WARNING!** Any electrical work required for the installation of this dishwasher should be carried out by a qualified, licensed electrician.
- **Power supply cord:** During installation, the power supply cord must not be excessively or dangerously bent or flattened. Do not tamper with the controls.
- **Safe disposal:** When removing an old dishwasher from service or discarding it, remove the door to the washing compartment.
- **Hose sets:** Only use new hose sets when connecting this dishwasher to the water supply; do not reuse old hoses.
- **Water pressure:** The maximum permissible inlet water pressure is 1MPa. The minimum permissible inlet water pressure is 0.04MPa.
- **Flammable objects:** Do not install the appliance on or near any flammable or hot objects.
- **Ventilation:** If there are any ventilation openings in the base, make sure they are not obstructed by carpet.
- **Proper installation:** Install the dishwasher on an even, flat and stable ground. Do not operate your dishwasher unless all enclosure panels are properly in place.

Usage conditions and restrictions

- **Domestic use only:** This appliance is intended for indoor household use only. It is not suitable for industrial, commercial or trade use. Do not use it for anything other than its intended purpose, and only use it as described in this manual.
- **Usage restriction:** The appliance is not intended for use by persons (including children) with reduced physical, sensory or mental capabilities, or lack of experience and knowledge, unless they have been given supervision or instruction concerning use of the appliance by a person responsible for their safety.

General Safety Instructions (Cont.)

- **Children** should be supervised to ensure they do not play with the appliance. Close supervision is necessary when any appliance is used by or near children.
- **WARNING!** Never leave the appliance unattended while in use.
- **Dishwasher door:** Do not abuse, sit on or stand on the door or dish rack of the dishwasher, or use it for anything other than its intended purpose. Do not place any heavy objects on the dishwasher door when it is open. The appliance could tip forward.

Open the door very carefully if the dishwasher is operating as there is a risk of water squirting out.

The door should not be left wide open as this could increase the risk of someone tripping over the door.

- **Safe loading:** Do not overload this dishwasher, it has a maximum capacity of 14 place settings. To ensure safe operation, follow a few simple rules when loading the dishwasher:
 - Place sharp items so they are not likely to damage the door seal.
 - Place long bladed knives and other utensils with sharp points with their points down in the basket or in a horizontal position to avoid potential hazards.
 - Only wash plastic items that are marked dishwasher safe or the equivalent. For plastic items not marked, check the manufacturer's recommendations.
- **Dishwasher detergent:** Use only detergent and rinse additives designed for an automatic dishwasher and keep them out of reach of children. Never use liquid detergent (for manual washing up), soap or laundry detergent in your dishwasher.

DANGER! Some dishwasher detergents are strongly alkaline and can be extremely dangerous if swallowed. Avoid contact with the skin and eyes.

DANGER! When the door of the dishwasher is open, make sure to keep children away from the dishwasher. Even after a wash there could still be detergent left inside. Make sure that the detergent compartment is empty after completion of the wash cycle.

- **Cleaning:** Unplug before cleaning and performing maintenance on the appliance. Use a soft cloth moistened with mild detergent for cleaning the appliance, and then use a dry cloth to wipe it again.
- **Do not modify** or not attempt to alter this appliance or its controls in any way.
- **Repair:** Do not attempt to take the unit apart. Apart from regular maintenance as described in this manual, this appliance is not designed to be dismantled by the user. In case of damage or malfunction, have the unit repaired by trained personnel only, or contact the after sales support line for advice.
- **Misuse:** Inappropriate use can result in property damage, injury or death. We assume no liability for misuse of the appliance or noncompliance with these instructions.

Product Overview

Scope of delivery

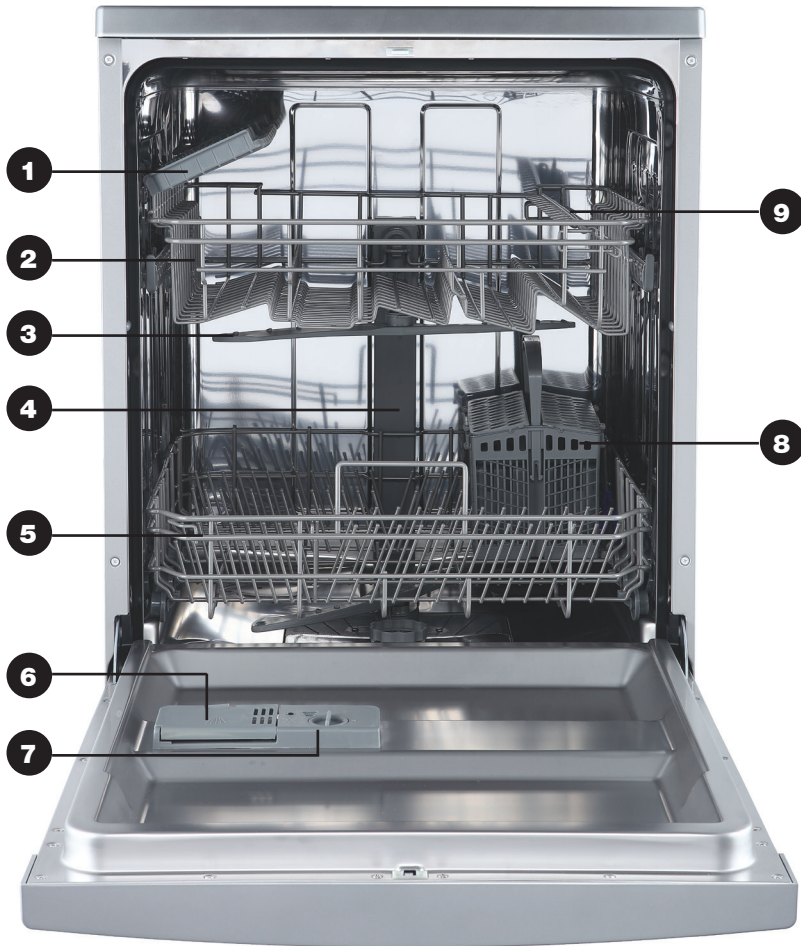

Dishwasher: front view, open

- | | | | |
|---|-----------------|---|---------------------|
| 1 | Cutlery rack | 5 | Lower basket |
| 2 | Upper basket | 6 | Detergent dispenser |
| 3 | Upper spray arm | 7 | Rinse aid dispenser |
| 4 | Inner pipe | 8 | Cutlery basket |
| | | 9 | Cup rack (foldable) |

Product Overview (Cont.)

Dishwasher: rear view

- 10 Drain hose
- 11 Water supply hose
- 12 Power cord and plug

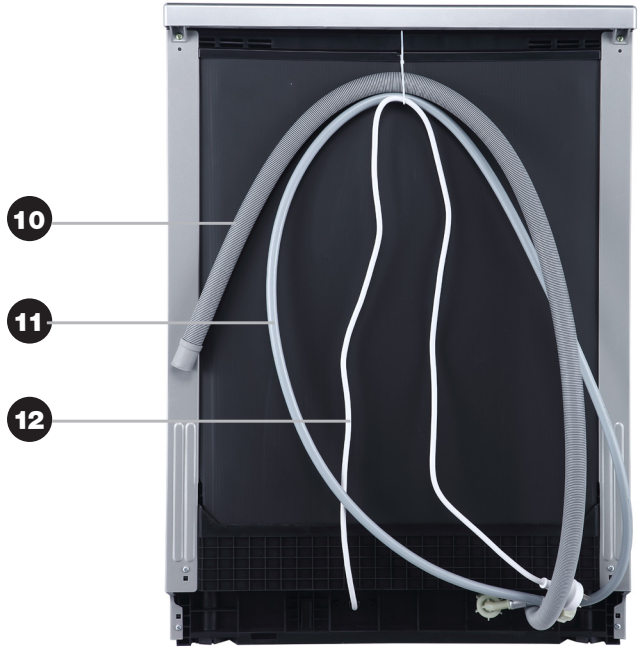

Documentation (not pictured)

- Instruction manual
- Warranty card

NOTE: Due to continued product improvement, images and illustrations in this manual may vary slightly from the product purchased. All images in this manual are for reference purposes only. Parts are not necessarily pictured to scale.

Product Overview (Cont.)

Control panel



| Operation buttons | | |
|--------------------|--|--|
| A | POWER | Press this button to enter or exit the ready-to-use state, the screen will light up. |
| B | PROGRAM | Press this button to select the appropriate washing program, the selected program indicator will light up. |
| C | EXTRA DRYING | Press this button to have dishes dried more thoroughly. (It can only be used with the Intensive, Heavy, Eco, Glass and 90 mins programs.) |
| D | HALF LOAD | Choose this function when you only have a small load (about 6 place settings or less) to wash, to save energy and water. (It can only be used with the Intensive, Heavy, Eco, Glass and 90 mins programs.) |
| E | CHILD LOCK | This option allows you to lock the buttons on the control panel so children cannot accidentally start the dishwasher. Only the POWER button remains active. To lock or unlock the control panel buttons, press and hold the HALF LOAD + DELAY buttons for 3 seconds simultaneously. |
| F | DELAY TIMER | Press this button to set the delayed hours for washing. You can delay the start of washing up to 3/6/9 hours. |
| G | START/PAUSE | Press this button to start the selected washing program or pause it when the dishwasher is working. |
| Display indicators | | |
| H | Intensive, Heavy, Eco, Glass, 90 mins, Rapid wash program indicators | |
| I | Half load and Extra Drying indicators | |
| J | Child lock indicator: illuminates when the child lock is set Rinse aid indicator: illuminates when a rinse aid refill is required Progress indicator: illuminates when the program has finished | |
| K | Delay time indicator: shows the delay time (3h/6h/9h) | |

Installation

DANGER! Make sure your electrical power is disconnected before installing the dishwasher. Failure to do so can result in death or electric shock.

IMPORTANT! All relevant pipes and electrical equipment should be installed by licensed plumbers, electricians or dishwasher installers. Make sure to use new water supply and drain hoses; do not use old hoses.

IMPORTANT! Read this manual to familiarise yourself with all parts and operating principles. Pay particular attention to the safety instructions.

Unpacking the appliance

- This product has been packaged to protect it against transportation damage. Unpack the appliance but keep all packaging materials until you have made sure your new dishwasher is undamaged and in good working order.
- The packaging carton is recyclable. Whenever possible, reuse the carton and recycle it when disposing of the packaging materials.
- Plastic wrapping can be a suffocation hazard for babies and young children, so ensure all packaging materials are out of their reach, and dispose of them safely.
- The baskets inside the dishwasher are taped to secure them during transport. Remove any tape, ties and foam padding from inside the dishwasher.
- **IMPORTANT!** Using the loading instructions on pages 16–19 for guidance, make sure all parts in the upper and lower baskets are properly installed inside the dishwasher – you may need to relocate the cup/cutlery rack for appropriate usage.
- Unwind the cord to its full length and inspect it for damage. Do not use if damaged. In case of damage, contact our after sales support centre for advice.

Positioning the appliance

- This dishwasher is freestanding. It can also be recessed under a single benchtop.
- Position the dishwasher close to an existing water inlet and drain connection and make sure there is a power point nearby, or in an adjoining cabinet.
- The back should rest against the wall behind it and the sides along any adjacent cabinets or walls.
- The dishwasher's water supply and drain hoses can be positioned either to the right or left sides to facilitate proper installation.
- Make sure the appliance does not stand on any water hoses or the power cable.

Installation (Cont.)

Levelling the appliance

- Position the dishwasher on a level and sturdy floor.
- If the floor is uneven, adjust the adjustable feet until it reaches a horizontal position; just screw the feet in or out a little (Fig. 1).
- The appliance should not be inclined more than 2°.
- Correctly levelled, the appliance will be more stable and much less likely to move or cause vibrations and noise during operation.

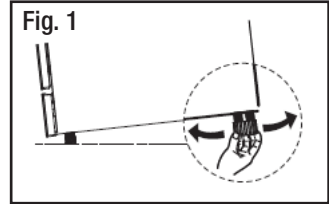

Freestanding installation

Between existing cabinets

- The height of the dishwasher, 845mm, has been designed in order to allow the machine to be fitted between existing cabinets of the same height in modern fitted kitchens (Fig. 2). The feet can be adjusted so that the correct height is reached.
- The laminated top of the machine does not require any particular care.

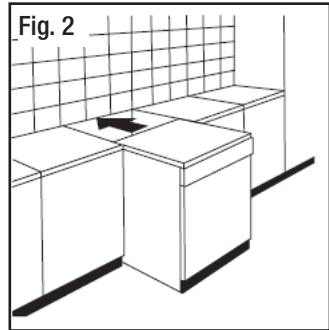

Underneath an existing worktop

- In most modern fitted kitchens there is only one single worktop under which cabinets and electrical appliances are fitted. If you want to fit this dishwasher under an existing worktop, you need to remove the worktop of the dishwasher by unscrewing the screws under the rear edge of the top (Fig. 3: a).

IMPORTANT! Keep the screws! After removing the worktop you will have to screw them back under the rear edge of the top (Fig. 3: b).

- The height of the dishwasher will then be reduced to 815mm (as per ISO regulations), which means it should fit perfectly under your kitchen worktop.

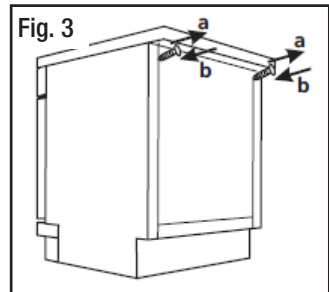

Installation (Cont.)

Cold water connection

- Connect the cold water supply hose to a threaded 3/4" connector. During use, the dishwasher will heat up the water to the required temperature. Make sure the hose is not kinked or squashed and is fastened tightly in place (Fig. 4).
- If the water pipes are new or have not been used for an extended period of time, let the water run to make sure it is clear and free of impurities. This step is necessary to avoid the risk of the water inlet being blocked and damaging the appliance.
- **WARNING!** Always close the water tap after using the dishwasher.

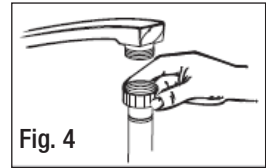

Drain hose connection

- The drain hose must be connected to the drain hose connector at the back of the dishwasher. Insert the drain hose into a drain pipe with a minimum diameter of 40mm, or let it run into the sink, making sure to avoid bending, crimping or squashing it. The height of drain pipe must be less than 1000mm from the floor. The free end of the hose must not be immersed in water to avoid the backflow of water.
- Follow the illustration below (Fig. 5) when installing the drain hose connection according to option A or B.
- The drain hose must be correctly fitted in order to prevent water leaks. It should be connected at a height of no more than 1m (maximum) and secured with a hose clip.
- If you need to drain any excess water from hoses and the sink is higher than 1m from the floor, you will need to drain the excess water into a bowl or container held underneath the pipe and lower than the sink.
- If you need a drain hose extension, make sure to use a similar hose that is no longer than 4 metres, otherwise the cleaning effect of the dishwasher could be reduced.

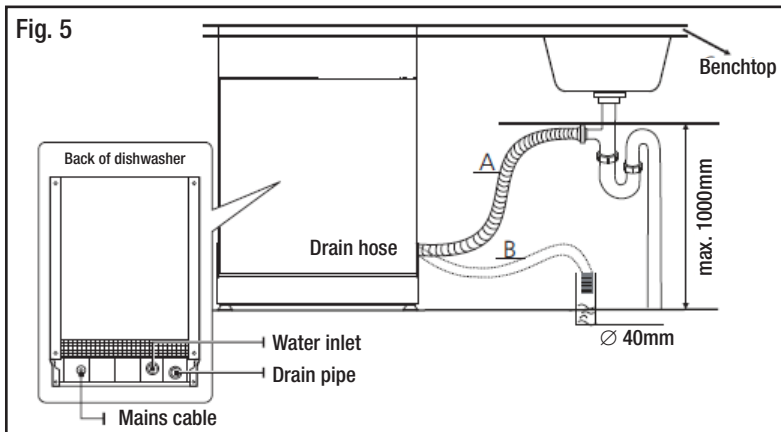

Installation (Cont.)

Electrical connection

Make sure that the electrical voltage and circuit frequency in your home correspond to those indicated on the appliance rating label and that the electrical system is sized for the maximum voltage on the rating plate. This appliance requires a 10A fused, copper-wired electrical supply. A time delay fuse or circuit breaker is recommended, as well as provision of a separate circuit serving only this appliance. A suitable power outlet should be located in an adjacent cabinet.

To connect the dishwasher, insert the plug into a properly earthed, easily accessible electrical socket. If the socket is not appropriate for the plug, replace the socket rather than use an adaptor or the like as such devices could cause overheating and burns.

WARNING!

- Do not use an extension cord or an adaptor with this appliance.
- Do not bend the power cord. Do not place the appliance on top of the cord.
- Do not modify the plug provided with this appliance. If it does not fit into your power point, have a suitable outlet installed by a qualified electrician.

Earthing

This appliance must be earthed. In the event of a malfunction or breakdown, earthing will reduce the risk of an electric shock by providing a path of least resistance for the electric current. This appliance is equipped with a cord having an equipment-earthing conductor and an earthing plug. The plug must be plugged into an appropriate outlet that is installed and earthed in accordance with all local standards and requirements.

WARNING!

- Ensure the outlet is properly earthed to the ground. If unsure, consult a qualified electrician or a service representative. Improper connection of the equipment grounding conductor can result in the risk of an electric shock if the appliance malfunctions.
- Do not, under any circumstances, cut or remove the third grounding prong from the power plug.

Before first use

After your new dishwasher has been installed, and before using it for the first time, make sure to check the following points to ensure safe and efficient operation:

- Is the dishwasher level and properly installed?
- Is the water tap open?
- Are the hose connections secured tightly and there is no leakage at either end?
- Are all electrical cords tightly connected?
- Is the power switched on at the power point?
- Are the inlet and drain hoses free of knots and kinks?
- Has all packing material been removed from the dishwasher?
- Is all product documentation stored safely for easy access?

Getting Started

Quick operation guide

For detailed operating instructions, please read the corresponding content in this manual.

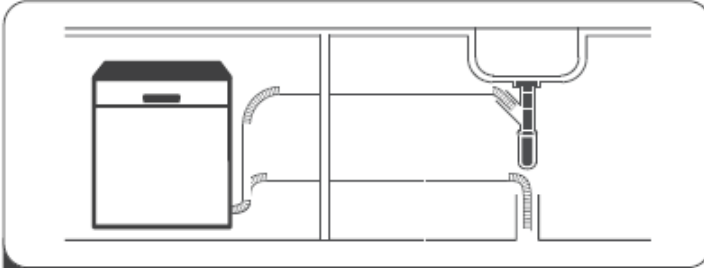

1 Install the dishwasher

Please refer to the “Installation” section on pages 09–12 in this manual. Make sure the water tap is open.



2 Prepare the dishes

Scrape off leftover food and soften burnt food residues with water.

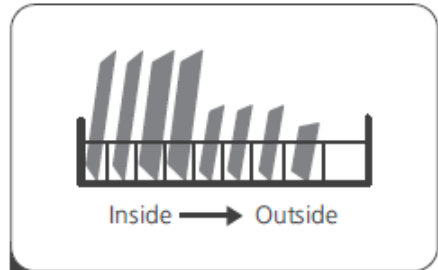

3 Load the baskets

Load the baskets following the dishwasher loading instructions on pages 16–19.

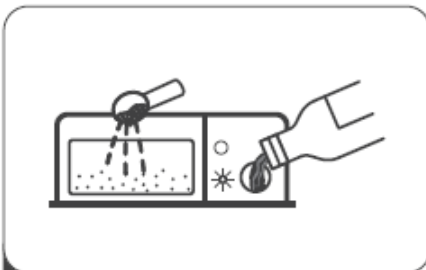

4 Fill/check the dispensers

Fill dishwasher detergent into the dispenser compartment and ensure there is liquid rinse aid in the dispenser (this is not necessary if you use a detergent with rinse aid).







5 Select a program and run the dishwasher

Close the door and press the PROGRAM button, then press START/PAUSE to start the program. At the end of the program, wait about 15 minutes before unloading.

Features

Wash programs and cycles

| Program | Suitability | Cycles |
|---|--|---|
| Intensive  | For the most heavily soiled loads, such as pots, pans, casserole dishes and dishes that have been sitting with dried food on them for a while. | Prewash (50°C) Wash (60°C) Rinse Rinse Rinse (65°C) Drying |
| Heavy  | For heavily soiled loads, such as pots, plates, cups, bowls and serving dishes. | Prewash (45°C) Wash (55°C) Rinse Rinse (65°C) Drying |
| ECO * | For normally soiled loads, such as plates, glasses, bowls and lightly soiled pots and pans: the recommended daily wash program. | Prewash Wash (45°C) Rinse (50°C) Drying |
| Glass  | For lightly soiled loads, such as glasses and fine china. | Prewash Wash (42°C) Rinse Rinse (60°C) Drying |
| 90 mins  | For lightly soiled loads that need a quick wash. | Wash (65°C) Rinse Rinse (65°C) Drying |
| Rapid  | A shorter wash for lightly soiled loads that do not need drying. | Wash (40°C) Rinse Rinse (45°C) |

* This program was used for testing the appliance to the Australian standard AS/NZS 2007.1 (tested with 14 place settings, rinse aid setting on 6, upper basket with the upper set of wheels on the rail support, and the door slightly opened (about 5cm) at the end of the program to assist with drying of the dishes).

Features (Cont.)

| Detergent (pre/main) | Running Time (min.) | Energy (kWh) | Water (L) |
|----------------------------|---------------------|--------------|-----------|
| 5 / 27.5g (or all-in-1) | 170 | 1.6 | 18.5 |
| 5 / 27.5g (or all-in-1) | 160 | 1.4 | 15 |
| 5 / 27.5g (or all-in-1) | 175 | 0.87 | 12.7 |
| 5 / 27.5g (or all-in-1) | 125 | 0.9 | 14.5 |
| 25g (or all-in-1) | 90 | 1.2 | 11.5 |
| 25g | 30 | 0.6 | 11.5 |

Instructions

Loading the dishwasher

For best performance of your dishwasher, follow the loading guidelines in this manual.

ATTENTION: Before loading the dishwasher baskets:

It is not necessary to rinse the dishes under running water before you put them into the dishwasher. However, we recommend you scrape off any large amounts of leftover food and soften remnants of burnt food in pots and pans.

Place objects in the dishwasher in the following way:

- Hollow items such as cups, glasses, pots, pans, etc. should be placed upside down so water cannot collect in the container or in a deep base.
- Curved items, or items with recesses, should be loaded at a slant so water can run off.
- All utensils should be stacked securely so they cannot tip over.
- All dishes and utensils should be placed in a way so the spray arms can rotate freely during washing.
- Very small items should not be washed in the dishwasher as they could easily fall out of the baskets and obstruct moving parts.
- Dishes and items of cutlery should not lie inside one another, or cover each other.
- To avoid damage to glasses, they must not touch.
- **WARNING!** Long bladed knives stored upright are a potential hazard! Always position these and other sharp cutlery items horizontally on the cup/cutlery racks.
- Do not overload your dishwasher; it will hold a maximum of 14 standard place settings. This is important for better washing results and lowers energy consumption.
- **WARNING!** Do not pull out the upper and lower basket at the same time, which can lead to the appliance tipping forward.

Protecting your glass and tableware

Much of today's tableware is dishwasher safe. However, not everything can be washed safely in a dishwasher. The chemical composition of your dishwasher detergent or the water temperature and duration of the wash program may adversely affect some materials. To protect your special cutlery, glass and tableware from damage, select a wash program with as low a temperature as possible (see pages 14–15 for program details).

We recommend you do not wash in a dishwasher the items listed below, and take special care with items deemed of limited suitability. And when buying new dishes, glassware, porcelain or cutlery, look for products labelled dishwasher safe.

Not suitable for the dishwasher: cutlery with wooden, china or mother-of-pearl handles; plastic items that are not heat resistant; older cutlery with glued parts that are not temperature resistant; bonded cutlery items or dishes; pewter or copper items; lead crystal glass; steel items subject to corrosion (rusting); wooden platters.

Of limited suitability: some types of glasses can become dull with frequent machine washing; items made of silver and aluminium tend to discolour from machine washing; glazed patterns may fade with frequent machine washing.

Instructions (Cont.)

Loading the upper basket

The upper basket is designed to hold more delicate and lighter tableware such as glasses, cups, small plates, bowls and shallow pans (as long as they are not too dirty).

Position these items securely so they do not get moved by the spray of water (Fig. 6).

Fig. 6:
Upper basket, loaded to fit 14 place settings

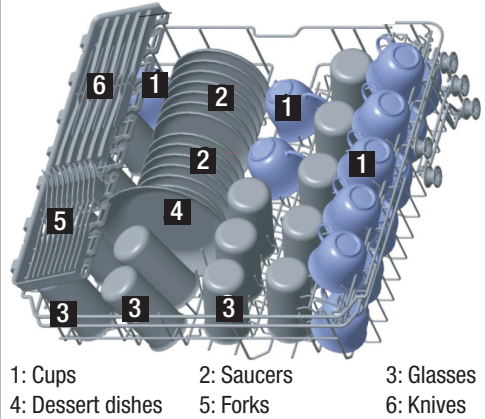

The cup/cutlery trays

Place long items, serving cutlery, salad servers, knives and similar lightweight items (max. 1.5kg) on one of the cup/cutlery racks (Fig. 7: A+B) in the upper basket, so that they do not obstruct the rotation of the spray arms. The extra rack (A) can be removed when not required for use. It can hold a maximum of 1.5kg. Rack (B) can be folded down for convenience.

Fig. 7

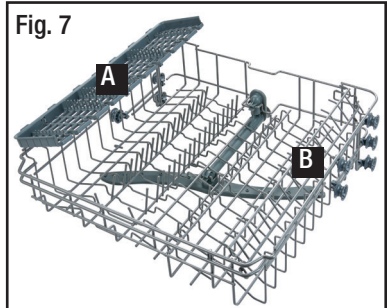

Adjusting the upper basket height

The height of the upper basket can easily be adjusted in order to create more space for large utensils in the upper or lower basket.

To adjust the height of the upper basket, pull the basket out and remove it from the dishwasher cabinet, then reinstall it with either the upper or lower wheels on the rails (Fig. 8).

Fig. 8: Lower position



Upper position



Instructions (Cont.)

Loading the lower basket

The lower basket is designed to hold dinner plates, larger items and the cutlery basket (Fig. 9).

Pots, pans, serving dishes and bowls are often the most difficult to clean and fit best into the lower basket. Always place pots, pans and bowls upside down into the basket or at a slant so the water can flow out (Fig. 10).

Load large serving dishes and lids on the side of the baskets so they do not block the rotation of the top spray arm. **To ensure the detergent dispenser lid can open freely, the maximum diameter for plates in front of the detergent dispenser is 19cm.**

Fig. 9: Lower basket, loaded to fit 14 place settings

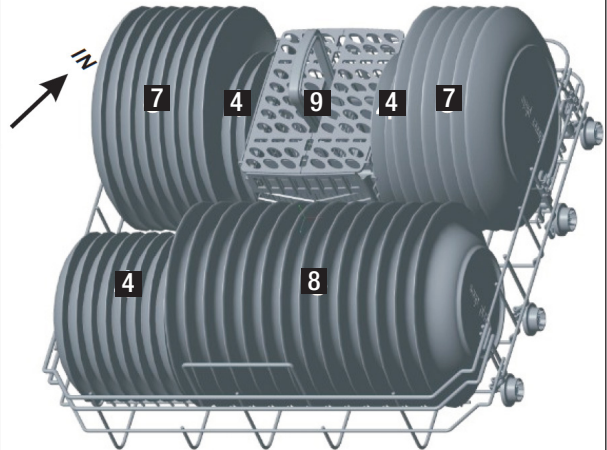

4: Dessert dishes - 7: Dinner plates - 8: Soup plates - 9: Cutlery basket

Fig. 10: Pots and pans in the lower basket

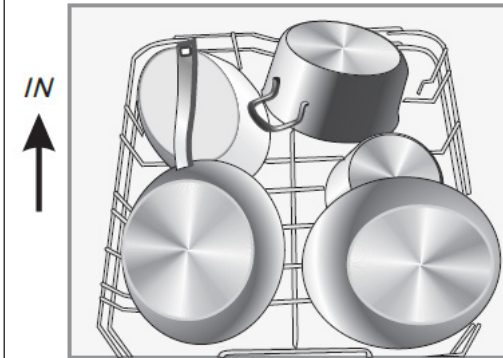

Fig. 11



Folding down the spike rows

If you need more space for pots and pans in the lower basket, you can fold down the spike rows at the back (Fig. 11: A), so that larger or more pots and pans can be loaded. Each row can be folded separately, or both together to obtain a larger area. To fold down the spike rows, release them from the frame using the blue clips at the side (Fig. 11: B).

Instructions (Cont.)

The cutlery basket

Your new dishwasher is equipped with a removable cutlery basket with anti-nesting grid.

You can use it with the anti-nesting grid up or down, as convenient (Fig. 12).

Fig. 13 shows you how to load the basket with the anti-nesting grid to hold a cutlery set for 14 people (where some of the cutlery pieces are loaded on the cutlery tray in the upper basket, as illustrated in Fig. 6).

For personal safety and top quality cleaning, place your dishwasher-safe standard size cutlery in the basket, making sure that:

- Cutlery is placed with the handles down.
- Items do not nest together (use of the anti-nesting grid will prevent this).
- Knives and other potentially dangerous utensils are placed sharp point down, or in a horizontal position on the cup/cutlery racks in the upper basket.
- No item extends through the bottom of the basket (Fig. 14).
- Long utensils are placed in a horizontal position on the cup/cutlery racks in the upper basket.

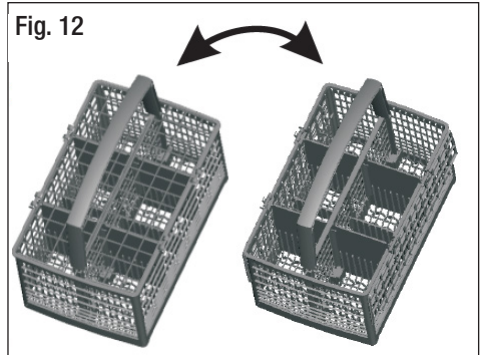
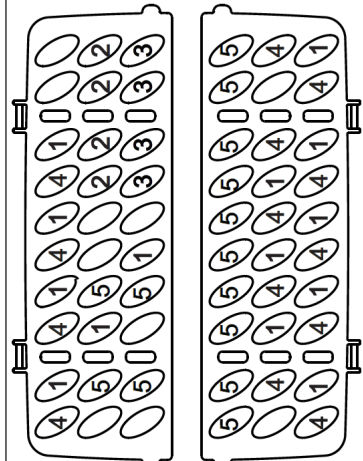

Fig. 12

Fig. 13



1: Soup spoons - 2: Forks - 3: Knives
4: Teaspoons - 5: Dessert spoons

WARNING!

- Do not let any item extend through the bottom of the basket.
- Always load sharp utensils with the sharp point down.

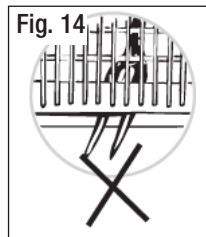

Fig. 14

Instructions (Cont.)

Dishwasher detergent

WARNING!

- Only use detergent specifically made for use in dishwashers.
- Always add detergent just before starting the dishwasher, otherwise it could get damp and will not dissolve properly. **It is also a hazard to leave detergent in the dispenser where children can reach it when the door is open.**
- **Dishwasher detergent is corrosive! Take care to keep it out of reach of children.**

Dishwasher detergents have chemical ingredients that remove dirt, food and germs and transport them out of the dishwasher. Most commercially sold dishwasher detergents are suitable for this purpose; they come in powder or tablet form.

Based on their chemical composition, dishwasher detergents can be split into two basic types: conventional, alkaline detergents with caustic components and low alkaline, concentrated detergents with enzymes.

Concentrated detergent

Using an “eco” washing program together with a concentrated detergent is better for the environment and good for your dishes; such wash programs are specifically matched to the dirt-dissolving properties in the enzymes of concentrated detergent. For this reason, an “eco” wash program in which a concentrated detergent is used can achieve the same results that otherwise only an “intensive” program can achieve.

Detergent tablets

Detergent tablets of different brands dissolve at different speeds; some cannot dissolve and develop their full cleaning power during short wash programs.

To ensure the complete removal of detergent residues, we recommend choosing longer wash programs when using dishwasher detergent tablets.

Instructions (Cont.)

The detergent dispenser

Fig. 15: Push latch to open

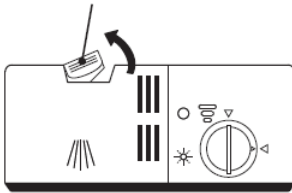
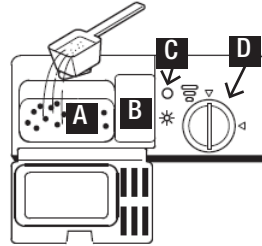

Fig. 16



Adding detergent

The table on page 15 lists the recommended amounts of detergent, generally one tablespoonful, or 25–27.5g. However, water hardness and soiling levels affect the amount of detergent required, and there are various types of detergent tablet on the market, so always follow the detergent manufacturer's recommendations on dosage.

- Before the start of each wash cycle fill an appropriate amount of detergent (or a detergent tablet) into the detergent dispenser. If the lid is closed, press the latch (Fig. 15) and the lid will spring open.
- For each wash cycle, fill dishwasher detergent (or a detergent tablet) into the detergent dispenser compartment (Fig. 16: A). If you are washing more heavily soiled dishes or using a program with a prewash cycle, also fill some detergent in compartment (16: B), if using powder detergent.
- Unless you use a detergent tablet with rinse aid, make sure there is sufficient liquid rinse aid in the rinse aid dispenser. Check the mechanical indicator (16: C), or the electronic indicator on the control panel. (See pages 22–23 for more on rinse aid.)
- Close the lid of the detergent dispenser and press until you hear it lock in place.

Instructions (Cont.)

Rinse aid

Rinse aid is automatically released during the last rinse to prevent water from forming droplets on your dishes, which can leave spots and streaks. It also improves drying by allowing water to roll off the dishes. Your dishwasher is designed to use liquid rinse aid.

CAUTION!

Only use specific, branded rinse aid for your dishwasher. Never fill the rinse aid dispenser with any other substances (e.g. dishwasher cleaning agent, liquid detergent) as this could damage the appliance.

Filling the rinse aid dispenser

The rinse aid dispenser is located inside the door next to the detergent dispenser. It holds about 110mL.

Fig. 17: Turn anticlockwise to open

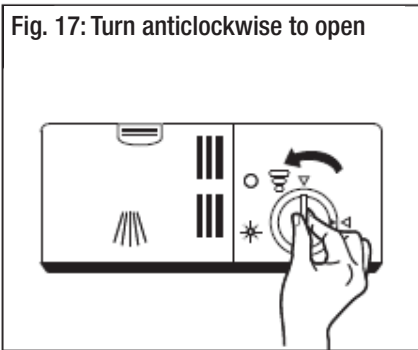
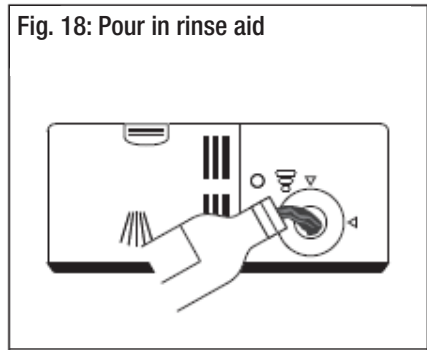
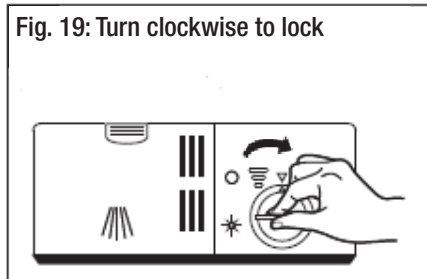

Fig. 18: Pour in rinse aid



- To open the dispenser, turn the cap in anticlockwise direction (left) and lift it out (Fig. 17).
- Carefully pour rinse aid into the dispenser until the level indicator turns completely black (Fig. 18). Take care not to overfill.
- Replace the cap in the opening and turn it clockwise (right) to close the dispenser (Fig. 19).

Fig. 19: Turn clockwise to lock



CAUTION!

Clean up any rinse aid spilled while filling with an absorbent cloth or paper towel to avoid excessive foaming during the next wash.

Do not forget to replace the cap before you close the dishwasher door.

Instructions (Cont.)

When to refill the rinse aid dispenser

Fill the rinse aid dispenser when the warning light [*] on the control panel comes on. Alternatively, you can estimate the amount of rinse aid left in the dispenser by the colour of the optical level indicator, which is located next to the cap (see Fig. 16: C on page 21). When the rinse aid container is full, the whole indicator will be dark. As the rinse aid diminishes, the size of the dark dot decreases, as indicated below. Never let the rinse aid level fall below 1/4 full.

- Full
- 3/4 Full
- 1/2 Full
- 1/4 Full - refill now to prevent spotting
- Empty

Adjusting the rinse aid dose

When you remove the cap from the rinse aid dispenser (Fig. 17), the dosage dial with six settings will be visible.

- Always start with the dispenser set on “4”, as illustrated (Fig. 20). If spots and poor drying are a problem, increase the amount of rinse aid dispensed by rotating the dial to “5”. If the dishes still are not drying properly or are showing spots, adjust the dial to level “6”.
- **Increase** the dose if there are drops of water or lime spots on the dishes after the wash.
- **Reduce** the dose if there are sticky whitish streaks on your dishes or a bluish film on glassware or knife blades.

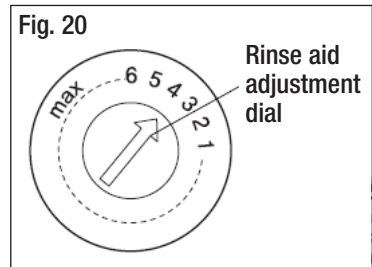

NOTE

If you are using detergent tablets that contain a rinse aid, you do not need to add liquid rinse aid and can ignore the rinse aid warning light when it comes on.

Instructions (Cont.)

Running the dishwasher

Starting a wash program

- Open the door and draw out the lower basket. Load your dishes and push the basket back into place. Then load the upper basket the same way.
- Add dishwasher detergent according to the instructions.
- Unless you use dishwasher detergent tablets that contain a rinse aid, make sure there is sufficient liquid rinse aid in the rinse aid dispenser.
- Close the dishwasher door, making sure you hear a click when it closes properly.
- Insert the plug into a suitable power socket (the power supply is 240V~ 50Hz) and make sure the water supply is turned on to full pressure.
- Press the **POWER** button on the dishwasher control panel.
- Press the **PROGRAM** button, repeatedly, to select the desired wash program from the following options: **Intensive - Heavy - Eco - Glass - 90 mins - Rapid**. The selected program's indicator light will illuminate.
- Press the **START/PAUSE** button to start the washing program.
- At the end of the program, press the **POWER** button to shut down the unit.
NOTE: We recommend you open the door slightly to assist in drying of the dishes.

Setting a delayed start

- Press the **DELAY** button, repeatedly, to select the desired delay time for the start of the selected washing program: 3 hours, 6 hours, 9 hours. The selected delay time's indicator light will illuminate.

Changing a program mid-cycle

If you want to change the wash program, you must do so soon after the start, otherwise the detergent may have already been released and the wash water drained, in which case you must reset the dishwasher and refill the detergent dispenser.

- Press the **START/PAUSE** button to pause the machine (Fig. 21).
- Press and hold the **PROGRAM** button for more than 3 seconds to cancel the program.
- Press the **PROGRAM** button, repeatedly, and select a different program.
- Close the door and press the **START/PAUSE** button to restart the dishwasher. It will start running again after 10 seconds.

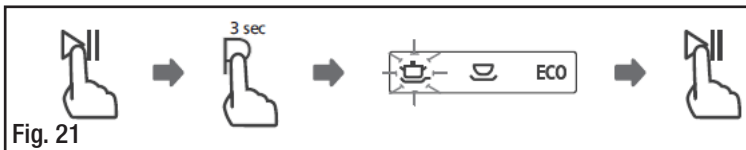

Fig. 21

Instructions (Cont.)

Forgot to add a dish?

Additional dishes can be added any time before the detergent dispenser opens.

- Press the **START/PAUSE** button to pause the washing (Fig. 22).
- Wait for 5 seconds, then open the door.
- Add additional dishes.
- Close the door.
- Press the **START/PAUSE** button to restart the dishwasher. It will start running again after 10 seconds.

WARNING! It is dangerous to open the door mid-cycle as hot water or steam may escape and scald you. Open the door very carefully.

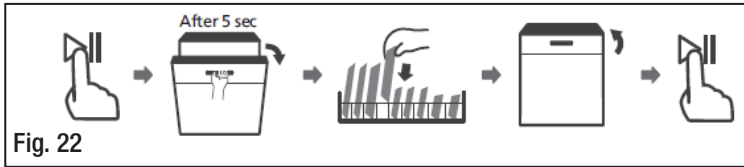

At the end of the wash program

A buzzer will sound for 8 seconds and then stop when the wash program has finished.

- Press the **POWER** button to shut down the unit and open the door — take care when opening the door as hot steam may escape.
- Leave the door ajar and wait at least a few minutes before unloading the dishwasher to avoid handling the dishes and utensils while they are still hot and more susceptible to breakage. They will also dry better. We recommend allowing dishes to cool for around 15 minutes before removing them from the dishwasher.
- When unloading the dishwasher, empty the lower basket first and then the upper one so water from the upper basket will not drip onto the dishes in the lower basket.

CAUTION! Do not pull out both the upper and lower basket at the same time, which may lead to the appliance tipping forward.

- It is normal that the dishwasher is wet inside. You may wipe the inside of the door with a dry cloth or leave the door slightly ajar for moisture to evaporate.

NOTE: If you are not going to use the dishwasher for a period of time, please shut off the water supply.

FAQs and Troubleshooting Guide

The table below lists possible causes and solutions for common problems you may encounter with the dishwasher. If you follow all the instructions below but still cannot solve a problem, please contact our after sales support centre.

| | Problem | Possible cause | Solution |
|--------------------|--|---|---|
| Technical problems | The dishwasher does not start. | The fuse is blown or the circuit breaker is activated. | Replace the fuse or reset the circuit breaker. Unplug any other appliances on the same circuit with the dishwasher. |
| | | The power supply is not turned on. | Ensure the power and the dishwasher are turned on, the cord is properly plugged in and the door is closed securely. |
| | | The water pressure is low. | Check that the water supply is connected properly and the water is turned on. |
| | | The dishwasher door is not properly closed. | Close the door properly and latch it. |
| | Water is not pumped out. | Kink in the drain hose. | Check the drain hose and ensure there are no kinks. |
| | | The filter is clogged. | Check and clean the coarse filter. |
| | | The kitchen sink is clogged. | Check and ensure the kitchen sink drains well. If the problem is the kitchen sink not draining, you may need a plumber rather than a dishwasher service technician. |
| Noise | Some audible sounds are normal, such as sound from water spraying, food remnants being shredded and the detergent dispenser opening. | | |
| | Knocking noise in the wash tub | A spray arm is knocking against an item in a basket. | Interrupt the program and rearrange the items that are obstructing the spray arm. |
| | Rattling noise in the wash tub | Utensils are not secure in the baskets or something small has dropped out of the baskets. | Interrupt the program and rearrange the loose crockery/cutlery items. |
| | Knocking noise in the water pipes | This may be caused by on-site installation or the cross section of the piping. | This has no influence on the dishwasher function. if in doubt, contact a suitably qualified plumber. |

FAQs and Troubleshooting Guide (Cont.)

| | Problem | Possible cause | Solution |
|-------------------------------|---|--|---|
| General problems | Suds in the tub | Inappropriate detergent | Use only specific dishwasher detergent to avoid suds. If this occurs, open the dishwasher and let the suds evaporate. Add 3–4 litres of cold water to the tub, close the door securely, then run any program. The dishwasher will drain out the water at the first step. Open the door after draining has stopped and check if the suds have disappeared. Repeat, if necessary. |
| | | Spilled rinse aid | Always wipe up rinse aid spills immediately. |
| | | A small amount of clean water around the outlet on the tub bottom is normal. It keeps the water seal lubricated. | |
| | White film on inside surface of the tub | Hard water minerals | To clean the interior, use a dishwasher cleaner made specially for that purpose. Alternatively, use a damp sponge with dishwasher detergent and wear rubber gloves. |
| | Rust stains on cutlery | The affected items are not corrosion resistant. | Cutlery must be corrosion resistant and dishwasher safe. |
| Unsatisfactory washing result | Dishes are not clean. | Wrong program selection | Select a more intensive wash program. |
| | | Improper basket loading | Make sure the action of the detergent dispenser and spray arms are not blocked by large tableware. |
| | | The filters are not clean, or incorrectly fitted, which may cause the spray arm jets to get blocked. | Clean and/or fit the filter assembly correctly. Clean the spray arm jets. |
| | Cloudiness on glassware | Combination of soft water and too much detergent | Use less detergent if you have soft water, and select a shorter program when washing glassware. |
| | Black or grey marks on dishes | Aluminum utensils have rubbed against dishes. | Use a mild abrasive cleaner to eliminate those marks. Avoid washing aluminium utensils in the dishwasher. |
| | Detergent left in dispenser | Incorrectly loaded dishes prevent the detergent cover from opening. | Reload the dishes properly to ensure nothing is blocking the detergent cover. |

FAQs and Troubleshooting Guide (Cont.)

| | Problem | Possible cause | Solution |
|------------------------------|-----------------------|---|---|
| Unsatisfactory drying result | Dishes are not dried. | Improper loading | Load the dishwasher as suggested in this manual. |
| | | Too little rinse aid | Increase the amount of rinse aid. Remove the cap from the rinse aid dispenser and set the dosage dial to a higher number. |
| | | No rinse aid | Refill the rinse aid dispenser. |
| | | Dishes are removed too soon after the program has finished. | Do not empty your dishwasher immediately after washing. Open the door slightly so that the steam can escape. Wait at least 15 minutes before unloading. Only start unloading the dishwasher when the dishes are barely warm to the touch. Empty the lower basket first to prevent water from dropping off dishes in the upper basket onto the dry dishes in the lower basket. |
| | | Wrong program selection | In shorter programs the rinse temperature is generally lower. This also lowers the drying performance. Choose a longer program with a higher rinse temperature. |
| | | Use of cutlery with a lower-quality coating | Water drainage is more difficult with these items. Cutlery or dishes of this type are not suitable for washing in the dishwasher. |

FAQs and Troubleshooting Guide (Cont.)

Error codes

When there is a malfunction, some of the indicator lights on the control panel will start flickering in order to warn you that something is wrong.

| Code | Meaning | Possible cause and solution |
|--|------------------------------------|--|
| The indicator for the “Rapid” wash flickers rapidly. | Longer inlet time. | Faucet is not opened, or water intake is restricted, or water pressure is too low — check and ensure the faucet is open and your water pressure is normal. |
| The indicators for the “Rapid” and “90 mins” wash flicker rapidly. | Not reaching required temperature. | Malfunction of heating element — call for service. |
| The indicator for the “Glass” wash flickers rapidly. | Overflow. | Some element of the dishwasher leaks — call for service. |

WARNING!

- If the code indicates a malfunction, overflow or leakage, shut down the dishwasher, turn off the power and close the water supply. Then call our after sales support center for advice, or contact a suitably qualified service technician.
- If there is water in the base of the tub because of an overflow or small leak, make sure to remove the water before restarting the dishwasher.

Other Useful Information

Cleaning and maintenance

The filtering system

The filtering system in the base of the wash cabinet efficiently removes food particles from the wash water, allowing it to be recycled during the wash. It prevents larger remnants of food or other objects from getting inside the pump.

The filtering system consists of three filters: a coarse filter, main filter and fine filter (Fig. 23).

1 Main (flat) filter

Food and soil particles trapped by this filter are pulverised by a special jet on the lower spray arm and washed down the drain.

2 Coarse filter

Larger items, such as pieces of bone or glass that could clog the drain, are trapped in the coarse filter. To remove an item caught in this filter, gently squeeze the tabs on the top of this filter and lift it out.

3 Fine (micro) filter

This filter holds dirt and food residues in the sump area and prevents them from being redeposited on the dishes during a wash cycle.

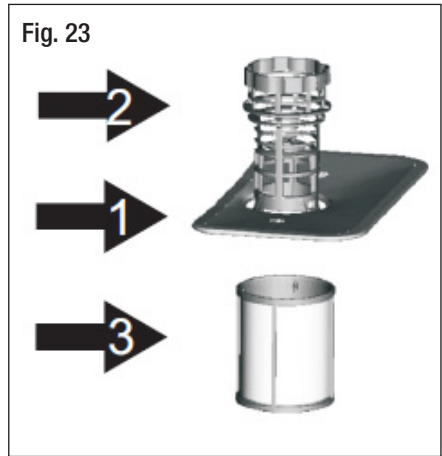

Removing/replacing the filter assembly

To ensure best performance, check the filter assembly after each wash and remove any larger food particles trapped inside the system.

The entire filtering system should be cleaned once a week.

- Turn the coarse filter in anticlockwise direction and then lift out the filtering system (Fig. 24: A + 24: B).
- The fine filter can be pulled off the bottom of the filter assembly. The coarse filter can be detached from the main filter by gently squeezing the tabs at the top and pulling it away.
- After cleaning the filters, replace them in reverse order. Replace the filter assembly and rotate it clockwise to secure.

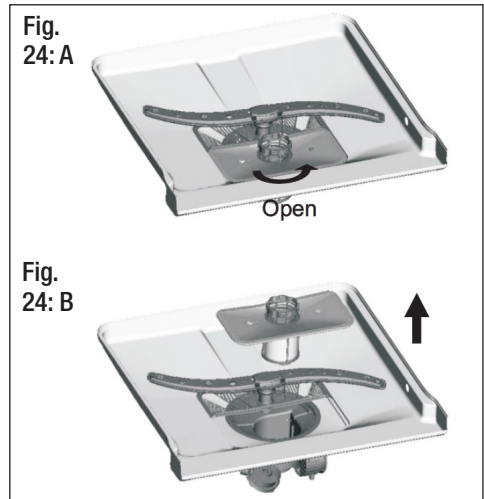

Other Useful Information (Cont.)

Cleaning the filters

- Remove any larger food remnants from the main filter and clean it under running water.
- For a more thorough clean, use a soft cleaning brush to clean the coarse filter and the fine filter.
- Reassemble the filter parts as illustrated opposite (Fig. 23) and reinsert the entire assembly in the dishwasher, positioning it in its seat and pressing downward.

WARNING!

- When cleaning the filters take care not to contort their shape, which could compromise the washing performance.
- Do not overtighten the filters. Put the filters back in sequence securely, otherwise coarse debris could get into the system and cause a blockage.
- Never use the dishwasher without the filters. Improper replacement of the filters may reduce the washing performance and damage dishes and utensils.

Cleaning the spray arms

The spray arms should be cleaned regularly to prevent clogging of the jets and bearings due to limescale or other hard water chemicals.

- First remove the upper spray arm, as illustrated (Fig. 25): hold the nut and rotate the arm to remove it.
- To remove the lower spray arm, pull it upwards, as illustrated.
- Wash both upper and lower spray arms in soapy, warm water and use a soft brush to clean the jets.
- Replace the spray arms after rinsing them thoroughly.

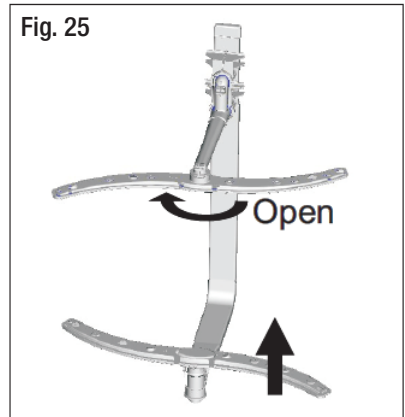

Other Useful Information (Cont.)

Cleaning the door and door seal

- Clean the door seals regularly with a soft damp cloth to remove food deposits.
- When the dishwasher is being loaded, food and drink residues may drip onto the sides of the dishwasher door. These surfaces are outside the wash cabinet and are not accessed by water from the spray arms. It is therefore important that you wipe off any deposits before you close the door.

Cleaning the control panel

- If cleaning is required, wipe the control panel with a soft, damp cloth only and dry the area thoroughly afterwards.

CAUTION!

- To prevent penetration of water into the door lock and electrical components, do not use a spray cleaner of any kind.
- Never use sharp objects, harsh or abrasive cleaners or scouring pads on any dishwasher surface because they will scratch the finish. Some papers towels may also scratch or leave marks on the surface.

Looking after your dishwasher

- **After every wash**, turn off the water supply to the appliance and leave the door slightly ajar so moisture and odours are not trapped inside.
- **Before cleaning** or performing maintenance, always unplug the dishwasher from the socket.

No solvents or abrasive cleaning

- To clean the exterior and rubber parts of the dishwasher, do not use solvents or abrasive cleaning products. Only use a cloth with warm, soapy water.
- To remove spots or stains from the surface of the interior, use a cloth dampened with water and a little white vinegar, or a cleaning product made specifically for dishwashers.
- Clean the door seals periodically with a damp sponge to remove any trapped food remnants and prevent odours developing inside the dishwasher.

Other Useful Information (Cont.)

In special situations

Going on holidays

When your dishwasher is not going to be used for some time, we recommend you run a wash cycle with the dishwasher empty and then unplug the dishwasher from the socket, turn off the water supply and leave the door slightly open. This will help with door seal durability and odour prevention inside the appliance.

Moving the dishwasher

If you must move the dishwasher, try to keep it in a vertical position. Only put it on its back if absolutely necessary.

Frost protection

If your dishwasher is left in an unheated place during winter and temperatures are likely to drop to below zero degrees Celsius, you should take certain precautions to prevent water freezing in the pipes. Unplug the dishwasher from the electrical power supply and turn off the water supply. Then ask an authorised service technician to:

- Disconnect the water inlet pipe from the water valve.
- Drain any water from the inlet pipe and water valve (use a pan to catch the water).
- Reconnect the water inlet pipe to the water valve.
- Remove the filter assembly from the bottom of the dishwasher and wipe up any water left in the sump with an absorbent sponge.

If your dishwasher does not work because of ice, contact a qualified service technician.

Other Useful Information (Cont.)

Service, repair and spare parts

If the appliance is damaged, do not attempt to repair it yourself. Do not disassemble or modify the appliance. If it requires repair or service, please contact our after sales support centre to arrange for a service.

Our after sales support centre stocks a wide range of spare parts for the dishwasher. To purchase a part email us at info@tempo.org.

- Adjustable foot
- Basket guides (upper and lower) and relevant front and rear blocks
- Basket assemblies (upper and lower)
- Control panel
- Cutlery tray
- Detergent dispenser and holder
- Display and PCBA for display
- Door lock assembly
- Door seals
- Drain hose and pump
- Filters: extractable cup, fine, flat, coarse
- Flowmeter (and inlet hose for such)
- Guide holder, front holder and wheels
- Handle
- Heater and relevant piping
- Temperature sensor
- Inlet hose
- Inner pipe and assembly
- Main PCBA and seal
- Microswitch
- Overflow float, hose and microswitch
- Power switch
- Pressure switch and hose
- Sprayer assemblies (upper and lower) and relevant parts (block, pipe, pipe holder)
- Sump assembly and seal
- Temperature sensor
- Tub gasket
- Water breaker (and inlet hose for such)
- Water inlet valve
- Washing pump and outlet duct
- Wheel assemblies (for upper and lower baskets)

Other Useful Information (Cont.)

Technical specifications

| | |
|--------------------------------|---|
| Model Number | AK-14PLSS |
| Capacity | 14 place settings |
| Rated voltage/frequency | 220-240V~ 50Hz |
| Power consumption | 1760–2100W |
| Water pressure (flow pressure) | 0.04–1.00 MPa = 0.4–10 bar |
| Height | 845mm |
| Width | 598mm |
| Depth | with door closed: 610mm with door open: 1175mm |
| Weight | 40kg |
| Liquid ingress protection | IPX1 |

Compliance

This product has been fully tested and meets all requirements as set out by standards AS/NZS 60335.1 and AS/NZS 60335.2.5.



The RCM Mark (Regulatory Compliance Mark) indicates that the product complies with the relevant guidelines of the ACMA as well as corresponding government requirements for the safety of electrical devices.

Responsible disposal

At the end of its working life, do not throw this appliance out with your household rubbish. Electrical and electronic products contain substances that can have a detrimental effect on the environment and human health if disposed of inappropriately.

When removing an old dishwasher from service or discarding it, remove the door to the washing compartment. Cut off the power supply cord and make the door closing mechanism unusable.

Observe any local regulations regarding the disposal of electrical consumer goods and dispose of it appropriately for recycling. Contact your local authorities for advice on recycling facilities in your area.

Warranty returns

Should you for any reason need to return this product for a warranty claim, make sure to include all accessories with the product.

Product does not work?



If you encounter problems with this product, or if it fails to perform to your expectations, make sure to contact our After Sales Support Centre for advice.

For an electronic copy of this manual, please contact our after sales support centre.

Instruction Manual Revision Index

| Version No | Issue Date | Description |
|------------|------------------|------------------|
| V1.0 | 03 December 2019 | Original release |

After Sales Support

 (AU) 1300 886 649 (NZ) 0800 836 761 |  info@tempo.org